



FREE CONSULTATION

 212.222.8288

Safety Tips For Solar Window Blinds For Your Children and Pets

by admin 

It is important for each of us to know how to raise awareness on the dangers of solar window blinds. Each year, many children are rushed to local emergency rooms due to injuries sustained when playing with the cords, or pulling on the cords that are part of window shades and window blinds. Pets have also been known to suffer from injuries due to these same types of cords.

As a parent, I feel that it is absolutely necessary to raise awareness of other parents and pet owners regarding this type of danger lurking in the home. Here, you will be taught how to know the dangers of window treatments.

The very first step that you can do to alert others on the dangers of window blinds is to observe these precautions in your own home. Make sure that all cords attached to solar window blinds are tied up highly. Not only will this help to avoid trips and potential falls, but it will divert the attention of children and animals from playing and pulling on the cords.

Window treatment in New York can install the best kind of window shades and window blinds together instruction on safety. Get the help of a window shades manufacturer in New York to give instruction on additional safety measures. By integrating safety in your own home, your visitors will see that you take the subject very seriously and may start to make the same changes and precautions in their homes, too.

The next thing that you can do to raise awareness about the dangers of cords on solar window blinds is to alert your local government. You should write letters to local legislators and those that work over your entire state. Persuade these individuals to make laws for daycare and educational facilities that require them to eliminate use of cords on window treatments.

In stating your case, it is important to offer alternatives for covering windows. This may include standard window treatments which can be purchased from a window blinds provider in New York.

To be honest, one of the last things that these officials have on their mind is safety with window blind cords. However, your letter will put this consideration out there.

If you have a knack for research, and can come up with some pretty strong evidence that solar window blinds pose potential dangers, you may elect to contact news reporters. You can choose those that work for local papers, or those that work on

March 2011

Sun	Mon	Tue	Wed	Thu	Fri	Sat	
		1	2	3	4	5	
6	7	8	9	10	11	12	
13	14	15	16	17	18	19	
20	21	22	23	24	25	26	
27	28	29	30	31			
<<	<					>	>>

Blinds New York

This blog is not for people who can't see. This blog is people who see too much! These people need tinting or window covering. I will not try to shade here a smile, so go ahead and write funny comments about Blinds and Shades...

[Recently](#)
[Archives](#)
[Categories](#)
[Latest comments](#)

Search



All Words

Some Word

television. These individuals have the ability to get the word out quickly.

They are always looking for a great news story, and something like blind cords that seems to be no danger at all, but prove to be a danger can make for some bold headlines! Now, you know how to raise awareness of the dangers of solar window blinds!

Categories: [Window blinds](#), [Blinds new york](#) Tags: [safety](#), [shades new york](#), [window blinds](#), [window blinds new york](#), [window shades](#), [window shades new york](#), [window treatment new york](#), [window treatment nyc](#), [window treatments](#)

 12/30/08 03:49:56 pm,  [Leave a comment »](#)



Entire phrase

Categories

All

Blinds new york

Motorized Shades

Shades new york

Window blinds

Window treatment

Save on your heating bill

by admin 

Windows

Windows can be one of your home's most attractive features. Windows provide views, daylighting, ventilation, and solar heating in the winter. Unfortunately, they can also account for 10% to 25% of your heating bill. During the summer, your air conditioner must work harder to cool hot air from sunny windows. Install **ENERGY STAR** windows and use curtains and shade to give your air conditioner and energy bill a break. If you live in the Sun Belt, look into new solar control spectrally selective windows, which can cut the cooling load by 10% to 15%.

If your home has single-pane windows, as almost half of U.S. homes do, consider replacing them. New doublepane windows with high-performance glass (e.g., low-e or spectrally selective) are available on the market. In colder climates, select windows that are gas filled with low emissivity (low-e) coatings on the glass to reduce heat loss. In warmer climates, select windows with spectrally selective coatings to reduce heat gain. If you are building a new home, you can offset some of the cost of installing more efficient windows because doing so allows you to buy smaller, less expensive heating and cooling equipment.

If you decide not to replace your windows, the simpler, less costly measures listed below can improve their performance.

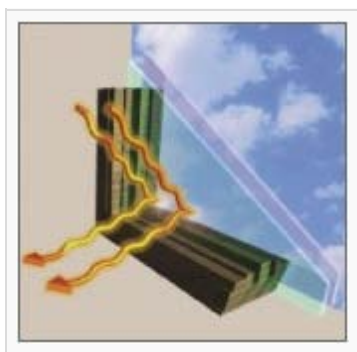

Cold Climate Windows Keep Heat In

Double-pane windows with low-e coating on the glass reflect heat back into the room during the winter months.

Cold-Climate Window Tips

You can use a heavy-duty, clear plastic sheet on a frame or tape clear plastic film to the inside of your window frames during the cold winter months. Remember, the plastic must be sealed tightly to the frame to help reduce infiltration.

Install tight-fitting, insulating window shades on windows that feel drafty after weatherizing.

XML Feeds

RSS 2.0: [Posts](#), [Comments](#)

Atom: [Posts](#), [Comments](#)

[What is RSS?](#)



Close your curtains and shades at night; open them during the day.
Keep windows on the south side of your house clean to let in the winter sun.
Install exterior or interior storm windows; storm windows can reduce heat loss through the windows by 25% to 50%. Storm windows should have weatherstripping at all moveable joints; be made of strong, durable materials; and have interlocking or overlapping joints. Low-e storm windows save even more energy.
Repair and weatherize your current storm windows, if necessary.

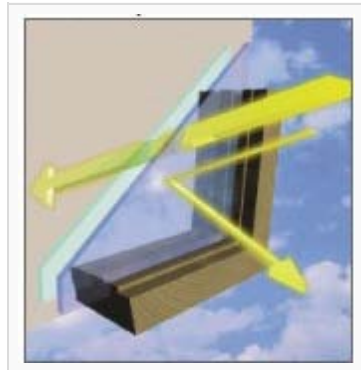

Warm Climate Windows Keep Heat Out

In the summertime, the sun shining through your windows heats up the room. Windows with spectrally selective coatings on the glass reflect some of the sunlight, keeping your rooms cooler.

Warm-Climate Window Tips

Install white window shades, drapes, or blinds to reflect heat away from the house.

Close curtains on south- and west-facing windows during the day.

Install awnings on south- and west-facing windows.

Apply sun-control or other reflective films on south-facing windows to reduce solar gain.

\$ Long-Term Savings Tip: Installing new, high-performance windows will improve your home's energy performance. While it may take many years for new windows to pay off in energy savings, the benefits of added comfort and improved aesthetics and functionality may make the investment worth it to you. Today, many new window technologies are available that are worth considering. Glazing materials (the glass part of the window) now come with a variety of selective coatings and other features; frames are available in aluminum, wood, vinyl, fiber glass, or combinations of these materials. Each type of glazing material and frame has advantages and disadvantages.

Shopping Tips for Windows

Look for the **ENERGY STAR**.

When you're shopping for new windows, look for the National Fenestration Rating Council label; it means the window's performance is certified.

Remember, the lower the U-value, the better the insulation. In colder climates, a U-value of 0.35 or below is recommended. These windows have at least double glazing and a low-e coating.



In warm climates, where summertime heat gain is the main concern, look for windows with double glazing and spectrally selective coatings that reduce heat gain.

Select windows with air leakage ratings of 0.3 cubic feet per minute or less.

In temperate climates with both heating and cooling seasons, select windows with both low U-values and low solar heat gain coefficient (SHGC) to maximize energy benefits.

Remember that new windows must be installed correctly to avoid air leaks around the frame. Look for a reputable, qualified installer.

Source: www1.eere.energy.gov

 08/28/08 09:37:10 am,  [Leave a comment »](#)



Some YouTube Movies



by admin 

Let's start with funny idea to [Clean Window Blinds](#)

[How to Measure Roller Shades - outside mount](#)

[How to Make Your Own Curtains](#). Window Treatments in Easy Steps. Sewing the Tabs Together.

Categories: [Window treatment](#)

 08/25/08 05:11:58 pm,  [Leave a comment »](#)



Welcome to the Shades & Blinds Blog

by admin 

This blog is not for people who can't see. This blog is people who see too much! These people need tinting or window covering. I will not try to shade here a smile, so go ahead and write funny comments about Blinds and Shades...



The Shades & Blinds Blog covers these topics:

- **Motorized Shades:** Functionality is second to none with the choice of operating motorized blinds by remote control, switches, timers, AV and Home Automation Systems. Visit our site for Motorized Blinds, PowerRise Motorized Blinds and PowerRise with Platinum Blinds.
- **Shades New York:** Create a warm and inviting setting with our Applause honeycomb shades, or a subtle hue with our Designer Screen shades, Duette honeycomb, Provenance woven wood, Trio Convertible and Vignette Modern Roman Shades.
- **Window Blinds:** At The Shade Company we have blinds to suit the entire family. Kid's Room Design, custom Design, Kids Roller Vcolor, safety rollerLine, Country Woods, L shape double open, Simple White Blinds and

Vertical Solutions.

- **Window Treatment:** Window treatments add refinement and style to otherwise dull, boring windows. Shutters and awnings decorate the outside of your house, while blinds, shades, cornices, trim and draperies enhance the inside appeal. Use the guides in this section to learn how to replace, install and decorate your windows.
- More to come...

Categories: [Window blinds](#)

 08/14/08 11:51:33 am,  [3 comments »](#)





Safety Tips For Solar Window Blinds For Your Children and Pets

by admin 

It is important for each of us to know how to raise awareness on the dangers of solar window blinds. Each year, many children are rushed to local emergency rooms due to injuries sustained when playing with the cords, or pulling on the cords that are part of window shades and window blinds. Pets have also been known to suffer from injuries due to these same types of cords.

As a parent, I feel that it is absolutely necessary to raise awareness of other parents and pet owners regarding this type of danger lurking in the home. Here, you will be taught how to know the dangers of window treatments.

The very first step that you can do to alert others on the dangers of window blinds is to observe these precautions in your own home. Make sure that all cords attached to solar window blinds are tied up highly. Not only will this help to avoid trips and potential falls, but it will divert the attention of children and animals from playing and pulling on the cords.

Window treatment in New York can install the best kind of window shades and window blinds together instruction on safety. Get the help of a window shades manufacturer in New York to give instruction on additional safety measures. By integrating safety in your own home, your visitors will see that you take the subject very seriously and may start to make the same changes and precautions in their homes, too.

The next thing that you can do to raise awareness about the dangers of cords on solar window blinds is to alert your local government. You should write letters to local legislators and those that work over your entire state. Persuade these individuals to make laws for daycare and educational facilities that require them to eliminate use of cords on window treatments.

In stating your case, it is important to offer alternatives for covering windows. This may include standard window treatments which can be purchased from a window blinds provider in New York.

To be honest, one of the last things that these officials have on their mind is safety with window blind cords. However, your letter will put this consideration out there.

If you have a knack for research, and can come up with some pretty strong evidence that solar window blinds pose potential dangers, you may elect to contact news reporters. You can choose those that work for local papers, or those that work on

March 2011

Sun	Mon	Tue	Wed	Thu	Fri	Sat
		1	2	3	4	5
6	7	8	9	10	11	12
13	14	15	16	17	18	19
20	21	22	23	24	25	26
27	28	29	30	31		
<< <			> >>			

Blinds New York

This blog is not for people who can't see. This blog is people who see too much! These people need tinting or window covering. I will not try to shade here a smile, so go ahead and write funny comments about Blinds and Shades...

Recently

Archives

Categories

Latest comments

Search

All Words
Some Word

television. These individuals have the ability to get the word out quickly.

They are always looking for a great news story, and something like blind cords that seems to be no danger at all, but prove to be a danger can make for some bold headlines! Now, you know how to raise awareness of the dangers of solar window blinds!

Categories: [Window blinds](#), [Blinds new york](#) Tags: [safety](#), [shades new york](#), [window blinds](#), [window blinds new york](#), [window shades](#), [window shades new york](#), [window treatment new york](#), [window treatment nyc](#), [window treatments](#)

 12/30/08 03:49:56 pm, [Leave a comment »](#)



Entire phrase

Categories

All

Blinds new york

Motorized Shades

Shades new york

Window blinds

Window treatment

Save on your heating bill

by admin 

Windows

Windows can be one of your home's most attractive features. Windows provide views, daylighting, ventilation, and solar heating in the winter. Unfortunately, they can also account for 10% to 25% of your heating bill. During the summer, your air conditioner must work harder to cool hot air from sunny windows. Install **ENERGY STAR** windows and use curtains and shade to give your air conditioner and energy bill a break. If you live in the Sun Belt, look into new solar control spectrally selective windows, which can cut the cooling load by 10% to 15%.

If your home has single-pane windows, as almost half of U.S. homes do, consider replacing them. New doublepane windows with high-performance glass (e.g., low-e or spectrally selective) are available on the market. In colder climates, select windows that are gas filled with low emissivity (low-e) coatings on the glass to reduce heat loss. In warmer climates, select windows with spectrally selective coatings to reduce heat gain. If you are building a new home, you can offset some of the cost of installing more efficient windows because doing so allows you to buy smaller, less expensive heating and cooling equipment.

If you decide not to replace your windows, the simpler, less costly measures listed below can improve their performance.

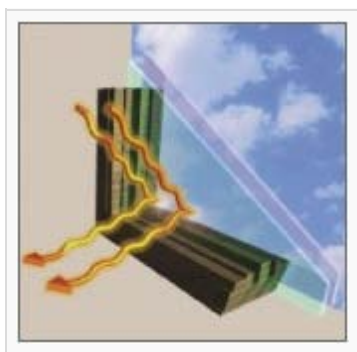

Cold Climate Windows Keep Heat In

Double-pane windows with low-e coating on the glass reflect heat back into the room during the winter months.

Cold-Climate Window Tips

You can use a heavy-duty, clear plastic sheet on a frame or tape clear plastic film to the inside of your window frames during the cold winter months. Remember, the plastic must be sealed tightly to the frame to help reduce infiltration.

Install tight-fitting, insulating window shades on windows that feel drafty after weatherizing.

XML Feeds

RSS 2.0: [Posts](#), [Comments](#)

Atom: [Posts](#), [Comments](#)

[What is RSS?](#)



Close your curtains and shades at night; open them during the day.
Keep windows on the south side of your house clean to let in the winter sun.
Install exterior or interior storm windows; storm windows can reduce heat loss through the windows by 25% to 50%. Storm windows should have weatherstripping at all moveable joints; be made of strong, durable materials; and have interlocking or overlapping joints. Low-e storm windows save even more energy.
Repair and weatherize your current storm windows, if necessary.

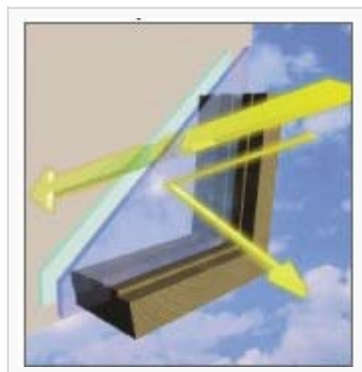

Warm Climate Windows Keep Heat Out

In the summertime, the sun shining through your windows heats up the room. Windows with spectrally selective coatings on the glass reflect some of the sunlight, keeping your rooms cooler.

Warm-Climate Window Tips

Install white window shades, drapes, or blinds to reflect heat away from the house.

Close curtains on south- and west-facing windows during the day.

Install awnings on south- and west-facing windows.

Apply sun-control or other reflective films on south-facing windows to reduce solar gain.

\$ Long-Term Savings Tip: Installing new, high-performance windows will improve your home's energy performance. While it may take many years for new windows to pay off in energy savings, the benefits of added comfort and improved aesthetics and functionality may make the investment worth it to you. Today, many new window technologies are available that are worth considering. Glazing materials (the glass part of the window) now come with a variety of selective coatings and other features; frames are available in aluminum, wood, vinyl, fiber glass, or combinations of these materials. Each type of glazing material and frame has advantages and disadvantages.

Shopping Tips for Windows

Look for the **ENERGY STAR**.

When you're shopping for new windows, look for the National Fenestration Rating Council label; it means the window's performance is certified.

Remember, the lower the U-value, the better the insulation. In colder climates, a U-value of 0.35 or below is recommended. These windows have at least double glazing and a low-e coating.



In warm climates, where summertime heat gain is the main concern, look for windows with double glazing and spectrally selective coatings that reduce heat gain.

Select windows with air leakage ratings of 0.3 cubic feet per minute or less.

In temperate climates with both heating and cooling seasons, select windows with both low U-values and low solar heat gain coefficient (SHGC) to maximize energy benefits.

Remember that new windows must be installed correctly to avoid air leaks around the frame. Look for a reputable, qualified installer.

Source: www1.eere.energy.gov

 08/28/08 09:37:10 am,  [Leave a comment »](#)



Some YouTube Movies



by admin 

Let's start with funny idea to [Clean Window Blinds](#)

[How to Measure Roller Shades - outside mount](#)

[How to Make Your Own Curtains](#). Window Treatments in Easy Steps. Sewing the Tabs Together.

Categories: [Window treatment](#)

 08/25/08 05:11:58 pm,  [Leave a comment »](#)



Welcome to the Shades & Blinds Blog

by admin 

This blog is not for people who can't see. This blog is people who see too much! These people need tinting or window covering. I will not try to shade here a smile, so go ahead and write funny comments about Blinds and Shades...



The Shades & Blinds Blog covers these topics:

- **Motorized Shades:** Functionality is second to none with the choice of operating motorized blinds by remote control, switches, timers, AV and Home Automation Systems. Visit our site for Motorized Blinds, PowerRise Motorized Blinds and PowerRise with Platinum Blinds.
- **Shades New York:** Create a warm and inviting setting with our Applause honeycomb shades, or a subtle hue with our Designer Screen shades, Duette honeycomb, Provenance woven wood, Trio Convertible and Vignette Modern Roman Shades.
- **Window Blinds:** At The Shade Company we have blinds to suit the entire family. Kid's Room Design, sustom Design, Kids Roller Vcolor, safety rollerLine, Country Woods, L shape double open, Simple White Blinds and

Vertical Solutions.

- **Window Treatment:** Window treatments add refinement and style to otherwise dull, boring windows. Shutters and awnings decorate the outside of your house, while blinds, shades, cornices, trim and draperies enhance the inside appeal. Use the guides in this section to learn how to replace, install and decorate your windows.
- More to come...

Categories: [Window blinds](#)

 08/14/08 11:51:33 am,  [3 comments »](#)



Blinds New York

By The Shade Company

Blinds NY

[Home](#)

[About The Shade Company](#)

[Contact](#)

[Log in](#)



THE SHADE COMPANY

FREE CONSULTATION

☎ 212.222.8288

ARCHIVE DIRECTORY

- [December 2008](#) (1)
- [August 2008](#) (4)

March 2011

Sun	Mon	Tue	Wed	Thu	Fri	Sat
		1	2	3	4	5
6	7	8	9	10	11	12
13	14	15	16	17	18	19
20	21	22	23	24	25	26
27	28	29	30	31		
<< <			> >>			

Blinds New York

This blog is not for people who can't see. This blog is people who see too much! These people need tinting or window covering. I will not try to shade here a smile, so go ahead and write funny comments about Blinds and Shades...

Recently

Archives

Categories

Latest comments

Search

All Words

Some Word
Entire phrase

Categories

All

Blinds new york

Motorized Shades

Shades new york

Window blinds

Window treatment

XML Feeds

RSS 2.0: [Posts](#), [Comments](#)

Atom: [Posts](#), [Comments](#)

[What is RSS?](#)





THE SHADE COMPANY

FREE CONSULTATION

 212.222.8288

CATEGORY DIRECTORY

- [All](#)
- [Blinds new york](#)
- [Motorized Shades](#)
- [Shades new york](#)
- [Window blinds](#)
- [Window treatment](#)

March 2011

Sun	Mon	Tue	Wed	Thu	Fri	Sat
		1	2	3	4	5
6	7	8	9	10	11	12
13	14	15	16	17	18	19
20	21	22	23	24	25	26
27	28	29	30	31		

<< < > >>

Blinds New York

This blog is not for people who can't see. This blog is people who see too much! These people need tinting or window covering. I will not try to shade here a smile, so go ahead and write funny comments about Blinds and Shades...

Recently

Archives

Categories

Latest comments

Search

All Words

Some Word
Entire phrase

Categories

All

Blinds new york

Motorized Shades

Shades new york

Window blinds

Window treatment

XML Feeds

RSS 2.0: [Posts](#), [Comments](#)

Atom: [Posts](#), [Comments](#)

[What is RSS?](#)





THE SHADE
COMPANY

FREE CONSULTATION

☎ 212.222.8288

LATEST COMMENTS

In response to: [About The Shade Company](#)

Jordan retro 10 [Visitor] · <http://www.airjordan.cc/air-jordan-10-29/>

Fantastic article. The information among your site is strictly fantastic, and your blog structure is Simple kind. It's easy to understand what you said. So excellent.

06/26/10 @ 00:57

[Permalink](#)

In response to: [About The Shade Company](#)

metal roof [Visitor] · <http://www.bratexusa.com/>

Date Hello, I have browsed most of your posts. This post is probably where I got the most useful information for my research. Thanks for posting, maybe we can see more on this. Are you aware of any other websites on this subject

04/30/10 @ 05:29

[Permalink](#)

In response to: [About The Shade Company](#)

Motorised Blinds [Visitor] · <http://www.ultrasound-blinds.co.uk/>

We at Ultrasound Blinds deliver high quality blinds that are convenient to operate from one place. Almost all types of window blinds of your requirements for all sizes of windows are available in motorized form of operating their function. Our costs for you are set within your buying capability as choices are many.

<http://www.ultrasound-blinds.co.uk/>

04/03/10 @ 01:12

[Permalink](#)

In response to: [About The Shade Company](#)

electronic gadgets [Visitor] · <http://electronicgadgetsblog.blogspot.com/>

this is a really nice site, thanks for not wasting my time with pointless drible that I find on a lot of other sites. Good work.

03/30/10 @ 19:55

[Permalink](#)

March 2011

Sun	Mon	Tue	Wed	Thu	Fri	Sat
		1	2	3	4	5
6	7	8	9	10	11	12
13	14	15	16	17	18	19
20	21	22	23	24	25	26
27	28	29	30	31		

<< < > >>

Blinds New York

This blog is not for people who can't see. This blog is people who see too much! These people need tinting or window covering. I will not try to shade here a smile, so go ahead and write funny comments about Blinds and Shades...

Recently

Archives

Categories

Latest comments

Search

All Words

In response to: [About The Shade Company](#)

Carter Ascenzo [Visitor] ·

<http://www.articlesrightnow.com/Art/86325/226/Tradeking-Review-Select-The-Greatest-Inventory-Broker-for-Online-Trades.html>

Thanks for the awesome publish I really like your blog. I have bookmarked it to learn later. I used to be having bother accessing your RSS feed although undecided if it was a problem my finish or right here?

03/29/10 @ 06:49

[Permalink](#)

In response to: [About The Shade Company](#)

Luciano Buster [Visitor] · <http://subscene.com/>

As a rule, I attempt to continue up with the comments and enter into dialog (as you have performed here) while using commenters. Dialog is so significantly added rewarding than just shouting out into the web. In the equal way as when you prepare an email or a blog post, have a think about it foremost and then perhaps respond if appropriate.

03/24/10 @ 13:50

[Permalink](#)

In response to: [Welcome to the Shades & Blinds Blog](#)

Dillon Hardisty [Visitor] · <http://unaico-sitetalk.net>

You got great honest points here. I done a search on the issue and learnt most peoples will agree with your blog.

02/28/10 @ 13:43

[Permalink](#)

In response to: [About The Shade Company](#)

Waylon Hillary [Visitor] · <http://unaico-sitetalk.net>

Heya€¦my very first comment on your site. ,I have been reading your blog for a while and thought I would completely pop in and drop a friendly note. . It is great stuff indeed. I also wanted to ask..is there a way to subscribe to your site via email?

02/28/10 @ 13:42

[Permalink](#)

In response to: [Welcome to the Shades & Blinds Blog](#)

Cayla [Visitor] · <http://www.pdfqueen.com>

Made my life easier...thanks

12/13/09 @ 10:41

[Permalink](#)

In response to: [About The Shade Company](#)

Solar Energy Guy [Visitor] · <http://www.greensolarenergy.co.cc>

Great Post, be sure to also check out our section on solar power battery chargers solar energy kits and more solar powered videos and tips.

www.greensolarenergy.co.cc

Green Solar Energy is the future!

05/05/09 @ 22:32

[Permalink](#)

In response to: [Welcome to the Shades & Blinds Blog](#)

Milo Darnello [Visitor] · <http://www.motorizedblinds.co.uk>

Some Word
Entire phrase

Categories

All

Blinds new york

Motorized Shades

Shades new york

Window blinds

Window treatment

XML Feeds

RSS 2.0: [Posts](#), [Comments](#)

Atom: [Posts](#), [Comments](#)

[What is RSS?](#)



Very nice blog, although I live in the UK I thought I might post something regarding the safety aspect of electric blinds. Many people are unaware that cord operated blinds are a safety hazzard where young children are concerned, sadly there are too many cases where children have got tangled in the cords. Electric blinds or shutters do not have this problem so are therefore safer, yes you may pay a little more but the benefits are 100 fold.

Kindest regards Hillary.

03/04/09 @ 13:59

 [Permalink](#)

Blinds New York

By The Shade Company

Blinds NY

Home

About The Shade Company

Contact

Log in



THE SHADE COMPANY

FREE CONSULTATION

212.222.8288

ARCHIVES FOR: MARCH 2011

Sorry, there is nothing to display...

March 2011

Sun	Mon	Tue	Wed	Thu	Fri	Sat
		1	2	3	4	5
6	7	8	9	10	11	12
13	14	15	16	17	18	19
20	21	22	23	24	25	26
27	28	29	30	31		

<< < > >>

Blinds New York

This blog is not for people who can't see. This blog is people who see too much! These people need tinting or window covering. I will not try to shade here a smile, so go ahead and write funny comments about Blinds and Shades...

Recently

Archives

Categories

Latest comments

Search

All Words

Some Word
Entire phrase

Categories

All

Blinds new york

Motorized Shades

Shades new york

Window blinds

Window treatment

XML Feeds

RSS 2.0: [Posts](#), [Comments](#)
Atom: [Posts](#), [Comments](#)

[What is RSS?](#)



Blinds New York

By The Shade Company

Blinds NY

Home

About The Shade Company

Contact

Log in



THE SHADE COMPANY

FREE CONSULTATION

☎ 212.222.8288

ARCHIVES FOR: MARCH 2010

Sorry, there is nothing to display...

March 2010

Sun	Mon	Tue	Wed	Thu	Fri	Sat
	1	2	3	4	5	6
7	8	9	10	11	12	13
14	15	16	17	18	19	20
21	22	23	24	25	26	27
28	29	30	31			
<<	<	Current	>	>>		

Blinds New York

This blog is not for people who can't see. This blog is people who see too much! These people need tinting or window covering. I will not try to shade here a smile, so go ahead and write funny comments about Blinds and Shades...

Recently

Archives

Categories

Latest comments

Search

All Words

Some Word
Entire phrase

Categories

All

Blinds new york

Motorized Shades

Shades new york

Window blinds

Window treatment

XML Feeds

RSS 2.0: [Posts](#), [Comments](#)
Atom: [Posts](#), [Comments](#)

[What is RSS?](#)



Blinds New York

By The Shade Company

Blinds NY

[Home](#)

[About The Shade Company](#)

[Contact](#)

[Log in](#)



THE SHADE
COMPANY

FREE CONSULTATION

☎ 212.222.8288

ARCHIVES FOR: FEBRUARY 2011

Sorry, there is nothing to display...

February 2011

Sun	Mon	Tue	Wed	Thu	Fri	Sat
		1	2	3	4	5
6	7	8	9	10	11	12
13	14	15	16	17	18	19
20	21	22	23	24	25	26
27	28					
<< <		Current		>		>>

Blinds New York

This blog is not for people who can't see. This blog is people who see too much! These people need tinting or window covering. I will not try to shade here a smile, so go ahead and write funny comments about Blinds and Shades...

Recently

Archives

Categories

Latest comments

Search

All Words

Some Word
Entire phrase

Categories

All

Blinds new york

Motorized Shades

Shades new york

Window blinds

Window treatment

XML Feeds

RSS 2.0: [Posts](#), [Comments](#)
Atom: [Posts](#), [Comments](#)

[What is RSS?](#)



Blinds New York

By The Shade Company

Blinds NY

[Home](#)

[About The Shade Company](#)

[Contact](#)

[Log in](#)



THE SHADE
COMPANY

FREE CONSULTATION

 212.222.8288

ARCHIVES FOR: APRIL 2011

Sorry, there is nothing to display...

April 2011

Sun	Mon	Tue	Wed	Thu	Fri	Sat
					1	2
3	4	5	6	7	8	9
10	11	12	13	14	15	16
17	18	19	20	21	22	23
24	25	26	27	28	29	30
<<	<	Current				>

Blinds New York

This blog is not for people who can't see. This blog is people who see too much! These people need tinting or window covering. I will not try to shade here a smile, so go ahead and write funny comments about Blinds and Shades...

Recently

Archives

Categories

Latest comments

Search

All Words

Some Word
Entire phrase

Categories

All

Blinds new york

Motorized Shades

Shades new york

Window blinds

Window treatment

XML Feeds

RSS 2.0: [Posts](#), [Comments](#)

Atom: [Posts](#), [Comments](#)

[What is RSS?](#)



Blinds New York

By The Shade Company

Blinds NY

Home

About The Shade Company

Contact

Log in



THE SHADE COMPANY

FREE CONSULTATION

☎ 212.222.8288

ARCHIVES FOR: MARCH 2012

Sorry, there is nothing to display...

March 2012

Sun	Mon	Tue	Wed	Thu	Fri	Sat	
				1	2	3	
4	5	6	7	8	9	10	
11	12	13	14	15	16	17	
18	19	20	21	22	23	24	
25	26	27	28	29	30	31	
<< <		Current					

Blinds New York

This blog is not for people who can't see. This blog is people who see too much! These people need tinting or window covering. I will not try to shade here a smile, so go ahead and write funny comments about Blinds and Shades...

Recently

Archives

Categories

Latest comments

Search

All Words

Some Word
Entire phrase

Categories

All

Blinds new york

Motorized Shades

Shades new york

Window blinds

Window treatment

XML Feeds

RSS 2.0: [Posts](#), [Comments](#)
Atom: [Posts](#), [Comments](#)

[What is RSS?](#)





Safety Tips For Solar Window Blinds For Your Children and Pets

by admin 

It is important for each of us to know how to raise awareness on the dangers of solar window blinds. Each year, many children are rushed to local emergency rooms due to injuries sustained when playing with the cords, or pulling on the cords that are part of window shades and window blinds. Pets have also been known to suffer from injuries due to these same types of cords.

As a parent, I feel that it is absolutely necessary to raise awareness of other parents and pet owners regarding this type of danger lurking in the home. Here, you will be taught how to know the dangers of window treatments.

The very first step that you can do to alert others on the dangers of window blinds is to observe these precautions in your own home. Make sure that all cords attached to solar window blinds are tied up highly. Not only will this help to avoid trips and potential falls, but it will divert the attention of children and animals from playing and pulling on the cords.

Window treatment in New York can install the best kind of window shades and window blinds together instruction on safety. Get the help of a window shades manufacturer in New York to give instruction on additional safety measures. By integrating safety in your own home, your visitors will see that you take the subject very seriously and may start to make the same changes and precautions in their homes, too.

The next thing that you can do to raise awareness about the dangers of cords on solar window blinds is to alert your local government. You should write letters to local legislators and those that work over your entire state. Persuade these individuals to make laws for daycare and educational facilities that require them to eliminate use of cords on window treatments.

In stating your case, it is important to offer alternatives for covering windows. This may include standard window treatments which can be purchased from a window blinds provider in New York.

To be honest, one of the last things that these officials have on their mind is safety with window blind cords. However, your letter will put this consideration out there.

If you have a knack for research, and can come up with some pretty strong evidence that solar window blinds pose potential dangers, you may elect to contact news reporters. You can choose those that work for local papers, or those that work on

March 2011

Sun	Mon	Tue	Wed	Thu	Fri	Sat
		1	2	3	4	5
6	7	8	9	10	11	12
13	14	15	16	17	18	19
20	21	22	23	24	25	26
27	28	29	30	31		
<< <			> >>			

Blinds New York

This blog is not for people who can't see. This blog is people who see too much! These people need tinting or window covering. I will not try to shade here a smile, so go ahead and write funny comments about Blinds and Shades...

Recently

Archives

Categories

Latest comments

Search



All Words

Some Word

television. These individuals have the ability to get the word out quickly.

They are always looking for a great news story, and something like blind cords that seems to be no danger at all, but prove to be a danger can make for some bold headlines! Now, you know how to raise awareness of the dangers of solar window blinds!

Categories: [Window blinds](#), [Blinds new york](#) Tags: [safety](#), [shades new york](#), [window blinds](#), [window blinds new york](#), [window shades](#), [window shades new york](#), [window treatment new york](#), [window treatment nyc](#), [window treatments](#)

 12/30/08 03:49:56 pm,  [Leave a comment »](#)



Feedback awaiting moderation

This post has 19 feedbacks awaiting moderation...

 [Comment feed for this post](#)

Leave a comment

Name:

Email:

Your email address will not be revealed on this site.

Website:

Your URL will be displayed.

Comment
text:

Options: **Auto-BR** (Line breaks become
)
Remember me (Name, email & website)
Allow message form (Allow users to contact you through a message form
(your email will not be revealed.)

Entire phrase

Categories

All

Blinds new york

Motorized Shades

Shades new york

Window blinds

Window treatment

XML Feeds

RSS 2.0: [Posts](#), [Comments](#)

Atom: [Posts](#), [Comments](#)

[What is RSS?](#)



Blinds New York

By The Shade Company

Blinds NY

Home

About The Shade Company

Contact

Log in



THE SHADE COMPANY

FREE CONSULTATION

212.222.8288

SEND AN EMAIL MESSAGE

To: admin

From: Your name.

Email: Your email address. (Will not be displayed on this site.)

Subject: Subject of email message.

Message:

Plain text only.

March 2011

Sun	Mon	Tue	Wed	Thu	Fri	Sat
		1	2	3	4	5
6	7	8	9	10	11	12
13	14	15	16	17	18	19
20	21	22	23	24	25	26
27	28	29	30	31		

<< < > >>

Blinds New York

This blog is not for people who can't see. This blog is people who see too much! These people need tinting or window covering. I will not try to shade here a smile, so go ahead and write funny comments about Blinds and Shades...

Recently

Archives

Categories

Latest comments

Search

All Words

Some Word
Entire phrase

Categories

All

Blinds new york

Motorized Shades

Shades new york

Window blinds

Window treatment

XML Feeds

RSS 2.0: [Posts](#), [Comments](#)
Atom: [Posts](#), [Comments](#)

[What is RSS?](#)



Blinds New York

By The Shade Company

Blinds NY

Home

About The Shade Company

Contact

Log in



THE SHADE COMPANY

FREE CONSULTATION

☎ 212.222.8288

ABOUT THE SHADE COMPANY

About The Shade Company

by admin 

The Shade Company is one of the leading manufacturers of window treatments that New York City has to offer. We specialize in all window adornments such as; blinds, shades, shutters, solar shades, skylight shades, office shades and custom drapery for all windows. Our wide selection of window shades, blinds drapes and silhouettes will accent and improve your room appearance while allowing the perfect flow of light through your windows .

The Shade Company offers a lifetime warranty on all window treatments and up to a year installation warranty. We provide FREE home consultations at your convenience to help you select the best option to suit your needs. Our expert representatives at The Shade Company provide fast installation and turnover. If you require any further assistance our friendly customer support will give you all the help you need.

Commercial Blinds

At The Shade Company, we understand that different businesses require different shading solutions. That's why we offer such a wide variety of blinds and awnings to meet your unique requirements.

From the sleekest blinds to the most sophisticated shades, The Shade Company's unique designs will not only improve the look of your business, they'll impress your clients too! Whether you're looking for that corporate edge or something a little more casual, we have infinite designs to suit your business' varying needs.

Our extensive range of blinds promise to give your office, hotel, nursing home, school, restaurant or store the ideal shading solution. Each commercial blind is uniquely designed according to your specific requirements, giving you the perfect fitting blind every time. The Shade Company will design a lighting solution for you that will allow your staff to work comfortably at computers without having to worry about any glare. The Shade Company also offers a variety of skylight solutions for offices that enjoy roof lighting.

March 2011

Sun	Mon	Tue	Wed	Thu	Fri	Sat	
		1	2	3	4	5	
6	7	8	9	10	11	12	
13	14	15	16	17	18	19	
20	21	22	23	24	25	26	
27	28	29	30	31			
<<	<					>	>>

Blinds New York

This blog is not for people who can't see. This blog is people who see too much! These people need tinting or window covering. I will not try to shade here a smile, so go ahead and write funny comments about Blinds and Shades...

Recently

Archives

Categories

Latest comments

Search

All Words

We can even customize your shades with your very own logo or design. There are so many reasons to choose The Shade Company's commercial shading for your business. Just a few reasons - our exceptional service, warranty, safety and our extensive range of shading designs.

For recommendations and a [FREE SHADE quote](#) - contact us today!

Window Blinds

When it comes to choosing the right shades or blinds for your windows, the best combination is to blend beauty with practicality. The Shade Company's wide selections of window blinds are unmatched throughout New York City for their range of decorative designs and styles, material selections and flexibility. If you're looking for the smart choice your windows then look no further than The Shade Company's unique selection listed below.

Flexibility

One of the key advantages of window blinds is their flexibility. Unlike many window coverings, window blinds permit the most accurate control over the amount of light or shade you would like in a room.

Whether you want warm rays of sunshine bursting through your windows or just small streams of light, horizontal blinds allow you achieve this - just by varying the position of their moveable slats.

Or maybe you'd prefer vertical blinds for their dramatic heightening effect and their flexibility and ease of letting more sunlight in or shutting all light out when you want a little privacy.

Material Selection

When buying window blinds from The Shade Company you can create your own sophisticated look with our wide selection of materials such as:

- Wood
- Faux wood
- PVC
- Vinyl
- Wood/vinyl blends
- Fabric
- Aluminum

Different looks can be achieved with these materials just by using applying them to either horizontal or vertical blinds. Or for a more decorative look, why not add one or more of our vibrant fabrics into the mix.

Decorative Designs & Styles

The Shade Company provides the most unique and diverse range of decorative styles that New York City has to offer. Whether you're looking for traditional or contemporary, rustic or New York chic - The Shade Company will tailor the design to suit your every desire.

Create a cool and sophisticated setting with our top of the line aluminum or a homely elegance with our beautifully designed fabrics. The Shade Company's selection of wood grains, slat widths and color tones, can subtly accentuate the textures and essence of any room to create the atmosphere you are searching for.

Window Shades

For homeowners who find the combination of blinds and window curtains too cluttered, window shades may provide the perfect solution. Window shades are an individual

Some Word
Entire phrase

Categories

- All
- Blinds new york
- Motorized Shades
- Shades new york
- Window blinds
- Window treatment

XML Feeds

RSS 2.0: [Posts](#), [Comments](#)
Atom: [Posts](#), [Comments](#)

[What is RSS?](#)



window treatment that offers the same controlled appearance as window blinds but share the same soft consistency of curtains.

When picking out window shades, look no further than The Shade Company for the best quality and diverse selection in New York City. Our window shades have the potential to turn any ordinary room into an exquisite environment. We can help you select the right type of shades to transform any room from drab to spontaneous, dull to romantic, and plain to chic. For instance, create a warm and inviting setting with our Applause honeycomb shades, or a subtle hue with our Designer Screen shades. You will be surprised at the endless options you have with our deluxe window shades!

Window Shutters

Indoor shutters are the latest in-vogue solution to window treatments. Shutters capture the very essence of modern interior styling and provide timeless beauty for any indoor setting. Functionality is also key benefit of shutters, allowing you to control both lighting and privacy simultaneously.

The Shade Company's shutters are available in fixed, hinged, sliding and bi-folding. You can choose timber, aluminum, PVC and foam shutters that are treated with an unlimited selection of painted, stained, oiled, lacquered, stained and powdercoated finishes, suitable for internal or external applications. The options and benefits of shutters are endless!

Make a Statement!

Window shutters and their bold design make for a chic and eye-catching arrangement for your windows. Forget your old drab, worn-out blinds and drapes, the clean and crisp lines of shutters will make you never turn back. Window shutters can fit into any décor whether you're looking for a traditional or contemporary look. Window shutters will certainly make a statement!

Easy to maintain

The beauty of shutters is that they are super easy to keep clean and maintain. All that is needed is a simple wipe with a damp cloth to remove dirt, dust or grime.

Improve energy efficiency

Window shutters great investment for decreasing the cost of your heating or cooling bills. Shutters provide great insulation so you'll find yourself using your heating or AC a whole lot less.

For the most unbeatable shutters that New York City has to offer look no further than The Shade Company. Our exotic Palm Beach polysatin shutters will create a cool calm environment for you to unwind in. If you want a warmer and more homely feel then our Heritage Hardwood Shutters may provide the perfect solution, fitting into any décor.

Window shutters are truly the most versatile window treatment on the market. Our shutters are custom made for the perfect fit, every time. So why not call The Shade Company today for your free quote!

Motorized Blinds

The Shade Company is New York City's specialist in motorized window treatments, supplying one of the most comprehensive ranges of technical sun shading and blind systems on the market today. In just a touch of a button you have the ease and versatility of moving shades up or down, and adjusting sunlight or shade. Motorized blinds offer convenience and are the perfect shading solution, especially for windows or skylights in hard-to-reach places.

Our Hunter Douglas' PowerRise system is one of the highest quality motorized blind systems on the market today. With no wiring required, our window shading system is easy to install and maintain. Functionality is second to none with the choice of operating our motorized blinds by remote control, switches, timers, AV and Home Automation Systems. You can even adjust our shades through sun sensors adding sophistication and style to any room or office.

Skylight Shades

The Shade Company is renowned for their top quality skylight shades. Skylight shades are the perfect solution for reducing any overheating in your house or office that may arise from sunlight coming through your skylights. The Shade Company specializes in deluxe shades that will keep you comfortable whilst saving energy. Our skylight shades are easily installed with our simple do-it-yourself instructions.

Our superior Verosol fabrics are of the finest quality and are second to none on performance. The Verosol pleated blind is elegant in design and highly functional with its microscopically thin layer of aluminum on one side, providing excellent sun shading qualities.

Balcony shades look great from any angle. Mounted on a unique track system, Balcony shades combine versatility and functionality with their smooth operation and greatly enhancing insulation qualities. Their side rail provides extra support, forming a barrier around the edge of the shades and their cellular shade fabrics are energy efficient.

When purchasing Verosol fabricated skylight shades you are assured of absolute quality control as all fabrics are processed in Verosol's own production facilities. Verosol pleated blinds are renowned for their long lasting ability, and pleat stability that stays in shape for years. Thus, making Verosol blinds the ideal solution for any skylight no matter the size or shape. Operation is extremely user-friendly with manual or motorized options. Fabrics range from non-transparent to ultra-transparent and come in colors that range from light grey to deep blue. Verosol blinds will truly fit into the design and color scheme of any room.



The Shade Company's range of skylight shades includes the most versatile and elegantly designed shades on the market. They are easy to install and maintain as they repel dust and rarely require cleaning. With our variety of skylight shades The Shade Company will find the perfect solution for you.

Kid's Room Design

At The Shade Company we have blinds to suit the entire family. Our endless range of kids' blinds and shades will turn your children's bedrooms into their very own playground. We can customize your child's shades to feature anything from their favorite cartoon character, animals, or colorful patterns and designs.

Our kids' blinds will brighten up any child's room. With our wide range can even help your create themed rooms such as nautical, jungle, animal safari, and outer space. So why not call us today so we can help you pick the perfect blinds for your child's room.

Categories: [Window blinds](#)

 08/14/08 11:51:23 am,  [8 comments »](#)



8 comments

Comment from: Solar Energy Guy [Visitor]  · <http://www.greensolarenergy.co.cc>

Great Post, be sure to also check out our section on solar power battery chargers solar energy kits and more solar powered videos and tips.

www.greensolarenergy.co.cc

Green Solar Energy is the future!

05/05/09 @ 22:32

Comment from: Waylon Hillary [Visitor] · <http://unaico-sitetalk.net>

Heya€¦my very first comment on your site. ,I have been reading your blog for a while and thought I would completely pop in and drop a friendly note. . It is great stuff indeed. I also wanted to ask..is there a way to subscribe to your site via email?

02/28/10 @ 13:42

Comment from: Luciano Buster [Visitor] · <http://subscene.com/>

As a rule, I attempt to continue up with the comments and enter into dialog (as you have performed here) while using commenters. Dialog is so significantly added rewarding than just shouting out into the web. In the equal way as when you prepare an email or a blog post, have a think about it foremost and then perhaps respond if appropriate.

03/24/10 @ 13:50

Comment from: Carter Ascenzo [Visitor] · <http://www.articlesrightnow.com/Art/86325/226/Tradeking-Review-Select-The-Greatest-Inventory-Broker-for-Online-Trades.html>

Thanks for the awesome publish I really like your blog. I have bookmarked it to learn later. I used to be having bother accessing your RSS feed although undecided if it was a problem my finish or right here?

03/29/10 @ 06:49

Comment from: electronic gadgets [Visitor] · <http://electronicgadgetsblog.blogspot.com/>

this is a really nice site, thanks for not wasting my time with pointless drible that I find on a lot of other sites. Good work.

03/30/10 @ 19:55

Comment from: Motorised Blinds [Visitor] · <http://www.ultrasound-blinds.co.uk/>

We at Ultrasound Blinds deliver high quality blinds that are convenient to operate from one place. Almost all types of window blinds of your requirements for all sizes of windows are available in motorized form of operating their function. Our costs for you are set within your buying capability as choices are many.

<http://www.ultrasound-blinds.co.uk/>

04/03/10 @ 01:12

Comment from: metal roof [Visitor] · <http://www.bratexusa.com/>

Date Hello, I have browsed most of your posts. This post is probably where I got the most useful information for my research. Thanks for posting, maybe we can see more on this. Are you aware of any other websites on this subject

04/30/10 @ 05:29

Comment from: Jordan retro 10 [Visitor] · <http://www.airjordan.cc/air-jordan-10-29/>

Fantastic article. The information among your site is strictly fantastic, and your blog structure is Simple kind. It's easy to understand what you said. So excellent.

06/26/10 @ 00:57

This post has 198 feedbacks awaiting moderation...



Comment feed for this post

Leave a comment

Name:

Email:

Your email address will **not** be revealed on this site.

Website:

Your URL will be displayed.

**Comment
text:**

Options:

Auto-BR (Line breaks become
)

Remember me (Name, email & website)

Allow message form (Allow users to contact you through a message form
(your email will not be revealed.)

Blinds New York

By The Shade Company

Blinds NY

Home

About The Shade Company

Contact

Log in



THE SHADE COMPANY

FREE CONSULTATION

☎ 212.222.8288

SEND AN EMAIL MESSAGE

To: admin

From: Your name.

Email: Your email address. (Will not be displayed on this site.)

Subject: Subject of email
message.

Message:

Plain text only.

March 2011

Sun	Mon	Tue	Wed	Thu	Fri	Sat
		1	2	3	4	5
6	7	8	9	10	11	12
13	14	15	16	17	18	19
20	21	22	23	24	25	26
27	28	29	30	31		

<< < > >>

Blinds New York

This blog is not for people who can't see. This blog is people who see too much! These people need tinting or window covering. I will not try to shade here a smile, so go ahead and write funny comments about Blinds and Shades...

Recently

Archives

Categories

Latest comments

Search

All Words

Some Word
Entire phrase

Categories

All

Blinds new york

Motorized Shades

Shades new york

Window blinds

Window treatment

XML Feeds

RSS 2.0: [Posts](#), [Comments](#)
Atom: [Posts](#), [Comments](#)

[What is RSS?](#)





Login form 

You will have to accept cookies in order to log in.

Login:

Password:

[Lost password ?](#)

[Abort login!](#)

b2evolution 2.4.2 – GPL License

©2001-2002 by Michel V & others – ©2003-2008 by François Planque & others.

Credits: [multiple blogs](#) | [webhosting](#)



THE SHADE
COMPANY

FREE CONSULTATION

☎ 212.222.8288

CATEGORY: BLINDS NEW YORK

Safety Tips For Solar Window Blinds For Your Children and Pets

by admin ✉

It is important for each of us to know how to raise awareness on the dangers of solar window blinds. Each year, many children are rushed to local emergency rooms due to injuries sustained when playing with the cords, or pulling on the cords that are part of window shades and window blinds. Pets have also been known to suffer from injuries due to these same types of cords.

As a parent, I feel that it is absolutely necessary to raise awareness of other parents and pet owners regarding this type of danger lurking in the home. Here, you will be taught how to know the dangers of window treatments.

The very first step that you can do to alert others on the dangers of window blinds is to observe these precautions in your own home. Make sure that all cords attached to solar window blinds are tied up highly. Not only will this help to avoid trips and potential falls, but it will divert the attention of children and animals from playing and pulling on the cords.

Window treatment in New York can install the best kind of window shades and window blinds together instruction on safety. Get the help of a window shades manufacturer in New York to give instruction on additional safety measures. By integrating safety in your own home, your visitors will see that you take the subject very seriously and may start to make the same changes and precautions in their homes, too.

The next thing that you can do to raise awareness about the dangers of cords on solar window blinds is to alert your local government. You should write letters to local legislators and those that work over your entire state. Persuade these individuals to make laws for daycare and educational facilities that require them to eliminate use of cords on window treatments.

In stating your case, it is important to offer alternatives for covering windows. This may include standard window treatments which can be purchased from a window blinds provider in New York.

To be honest, one of the last things that these officials have on their mind is safety with window blind cords. However, your letter will put this consideration out there.

If you have a knack for research, and can come up with some pretty strong evidence that solar window blinds pose potential dangers, you may elect to contact news

March 2011

Sun	Mon	Tue	Wed	Thu	Fri	Sat
		1	2	3	4	5
6	7	8	9	10	11	12
13	14	15	16	17	18	19
20	21	22	23	24	25	26
27	28	29	30	31		

<< < > >>

Blinds New York

This blog is not for people who can't see. This blog is people who see too much! These people need tinting or window covering. I will not try to shade here a smile, so go ahead and write funny comments about Blinds and Shades...

Recently

Archives

Categories

Latest comments



Search

All Words

reporters. You can choose those that work for local papers, or those that work on television. These individuals have the ability to get the word out quickly.

They are always looking for a great news story, and something like blind cords that seems to be no danger at all, but prove to be a danger can make for some bold headlines! Now, you know how to raise awareness of the dangers of solar window blinds!

Categories: [Window blinds](#), [Blinds new york](#) Tags: [safety](#), [shades new york](#), [window blinds](#), [window blinds new york](#), [window shades](#), [window shades new york](#), [window treatment new york](#), [window treatment nyc](#), [window treatments](#)

 12/30/08 03:49:56 pm,  [Leave a comment »](#)



Some Word
Entire phrase

Categories

All

[Blinds new york](#)

[Motorized Shades](#)

[Shades new york](#)

[Window blinds](#)

[Window treatment](#)

XML Feeds

RSS 2.0: [Posts](#), [Comments](#)
Atom: [Posts](#), [Comments](#)

[What is RSS?](#)



Blinds New York

By The Shade Company

Blinds NY

Home

About The Shade Company

Contact

Log in



THE SHADE COMPANY

FREE CONSULTATION

☎ 212.222.8288

CATEGORY: MOTORIZED SHADES

Sorry, there is nothing to display...

March 2011

Sun	Mon	Tue	Wed	Thu	Fri	Sat
		1	2	3	4	5
6	7	8	9	10	11	12
13	14	15	16	17	18	19
20	21	22	23	24	25	26
27	28	29	30	31		

<< < > >>

Blinds New York

This blog is not for people who can't see. This blog is people who see too much! These people need tinting or window covering. I will not try to shade here a smile, so go ahead and write funny comments about Blinds and Shades...

Recently

Archives

Categories

Latest comments

Search

All Words

Some Word
Entire phrase

Categories

All

Blinds new york

Motorized Shades

Shades new york

Window blinds

Window treatment

XML Feeds

RSS 2.0: [Posts](#), [Comments](#)
Atom: [Posts](#), [Comments](#)

[What is RSS?](#)



Blinds New York

By The Shade Company

Blinds NY

Home

About The Shade Company

Contact

Log in



THE SHADE COMPANY

FREE CONSULTATION

☎ 212.222.8288

CATEGORY: SHADES NEW YORK

Sorry, there is nothing to display...

March 2011

Sun	Mon	Tue	Wed	Thu	Fri	Sat
		1	2	3	4	5
6	7	8	9	10	11	12
13	14	15	16	17	18	19
20	21	22	23	24	25	26
27	28	29	30	31		

<< < > >>

Blinds New York

This blog is not for people who can't see. This blog is people who see too much! These people need tinting or window covering. I will not try to shade here a smile, so go ahead and write funny comments about Blinds and Shades...

Recently

Archives

Categories

Latest comments

Search

All Words

Some Word
Entire phrase

Categories

All

Blinds new york

Motorized Shades

Shades new york

Window blinds

Window treatment

XML Feeds

RSS 2.0: [Posts](#), [Comments](#)
Atom: [Posts](#), [Comments](#)

[What is RSS?](#)





THE SHADE
COMPANY

FREE CONSULTATION

☎ 212.222.8288

CATEGORY: WINDOW BLINDS

Safety Tips For Solar Window Blinds For Your Children and Pets

by admin ✉

It is important for each of us to know how to raise awareness on the dangers of solar window blinds. Each year, many children are rushed to local emergency rooms due to injuries sustained when playing with the cords, or pulling on the cords that are part of window shades and window blinds. Pets have also been known to suffer from injuries due to these same types of cords.

As a parent, I feel that it is absolutely necessary to raise awareness of other parents and pet owners regarding this type of danger lurking in the home. Here, you will be taught how to know the dangers of window treatments.

The very first step that you can do to alert others on the dangers of window blinds is to observe these precautions in your own home. Make sure that all cords attached to solar window blinds are tied up highly. Not only will this help to avoid trips and potential falls, but it will divert the attention of children and animals from playing and pulling on the cords.

Window treatment in New York can install the best kind of window shades and window blinds together instruction on safety. Get the help of a window shades manufacturer in New York to give instruction on additional safety measures. By integrating safety in your own home, your visitors will see that you take the subject very seriously and may start to make the same changes and precautions in their homes, too.

The next thing that you can do to raise awareness about the dangers of cords on solar window blinds is to alert your local government. You should write letters to local legislators and those that work over your entire state. Persuade these individuals to make laws for daycare and educational facilities that require them to eliminate use of cords on window treatments.

In stating your case, it is important to offer alternatives for covering windows. This may include standard window treatments which can be purchased from a window blinds provider in New York.

To be honest, one of the last things that these officials have on their mind is safety with window blind cords. However, your letter will put this consideration out there.

If you have a knack for research, and can come up with some pretty strong evidence that solar window blinds pose potential dangers, you may elect to contact news

March 2011

Sun	Mon	Tue	Wed	Thu	Fri	Sat	
		1	2	3	4	5	
6	7	8	9	10	11	12	
13	14	15	16	17	18	19	
20	21	22	23	24	25	26	
27	28	29	30	31			
<<	<					>	>>

Blinds New York

This blog is not for people who can't see. This blog is people who see too much! These people need tinting or window covering. I will not try to shade here a smile, so go ahead and write funny comments about Blinds and Shades...

Recently

Archives

Categories

Latest comments



Search

All Words

reporters. You can choose those that work for local papers, or those that work on television. These individuals have the ability to get the word out quickly.

They are always looking for a great news story, and something like blind cords that seems to be no danger at all, but prove to be a danger can make for some bold headlines! Now, you know how to raise awareness of the dangers of solar window blinds!

Categories: [Window blinds](#), [Blinds new york](#) Tags: [safety](#), [shades new york](#), [window blinds](#), [window blinds new york](#), [window shades](#), [window shades new york](#), [window treatment new york](#), [window treatment nyc](#), [window treatments](#)

 12/30/08 03:49:56 pm,  [Leave a comment »](#)



Some Word
Entire phrase

Categories

All

[Blinds new york](#)

[Motorized Shades](#)

[Shades new york](#)

[Window blinds](#)

[Window treatment](#)

Save on your heating bill

by admin 

Windows

Windows can be one of your home's most attractive features. Windows provide views, daylighting, ventilation, and solar heating in the winter. Unfortunately, they can also account for 10% to 25% of your heating bill. During the summer, your air conditioner must work harder to cool hot air from sunny windows. Install **ENERGY STAR** windows and use curtains and shade to give your air conditioner and energy bill a break. If you live in the Sun Belt, look into new solar control spectrally selective windows, which can cut the cooling load by 10% to 15%.

If your home has single-pane windows, as almost half of U.S. homes do, consider replacing them. New doublepane windows with high-performance glass (e.g., low-e or spectrally selective) are available on the market. In colder climates, select windows that are gas filled with low emissivity (low-e) coatings on the glass to reduce heat loss. In warmer climates, select windows with spectrally selective coatings to reduce heat gain. If you are building a new home, you can offset some of the cost of installing more efficient windows because doing so allows you to buy smaller, less expensive heating and cooling equipment.

If you decide not to replace your windows, the simpler, less costly measures listed below can improve their performance.

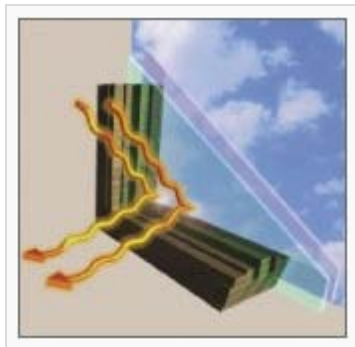

Cold Climate Windows Keep Heat In

Double-pane windows with low-e coating on the glass reflect heat back into the room during the winter months.

Cold-Climate Window Tips

You can use a heavy-duty, clear plastic sheet on a frame or tape clear plastic film to the inside of your window frames during the cold winter months. Remember, the plastic must be sealed tightly to the frame to help reduce infiltration.

Install tight-fitting, insulating window shades on windows that feel drafty after

XML Feeds

RSS 2.0: [Posts](#), [Comments](#)
Atom: [Posts](#), [Comments](#)

[What is RSS?](#)



weatherizing.

Close your curtains and shades at night; open them during the day.

Keep windows on the south side of your house clean to let in the winter sun.

Install exterior or interior storm windows; storm windows can reduce heat loss through the windows by 25% to 50%. Storm windows should have weatherstripping at all moveable joints; be made of strong, durable materials; and have interlocking or overlapping joints. Low-e storm windows save even more energy.

Repair and weatherize your current storm windows, if necessary.

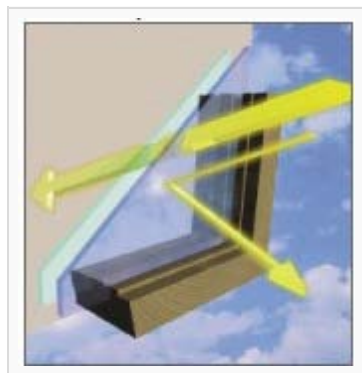

Warm Climate Windows Keep Heat Out

In the summertime, the sun shining through your windows heats up the room. Windows with spectrally selective coatings on the glass reflect some of the sunlight, keeping your rooms cooler.

Warm-Climate Window Tips

Install white window shades, drapes, or blinds to reflect heat away from the house.

Close curtains on south- and west-facing windows during the day.

Install awnings on south- and west-facing windows.

Apply sun-control or other reflective films on south-facing windows to reduce solar gain.

\$ Long-Term Savings Tip: Installing new, high-performance windows will improve your home's energy performance. While it may take many years for new windows to pay off in energy savings, the benefits of added comfort and improved aesthetics and functionality may make the investment worth it to you. Today, many new window technologies are available that are worth considering. Glazing materials (the glass part of the window) now come with a variety of selective coatings and other features; frames are available in aluminum, wood, vinyl, fiber glass, or combinations of these materials. Each type of glazing material and frame has advantages and disadvantages.

Shopping Tips for Windows

Look for the **ENERGY STAR**.

When you're shopping for new windows, look for the National Fenestration Rating Council label; it means the window's performance is certified.

Remember, the lower the U-value, the better the insulation. In colder climates, a U-value of 0.35 or below is recommended. These windows have at least double glazing and a low-e coating.

In warm climates, where summertime heat gain is the main concern, look for windows with double glazing and spectrally selective coatings that reduce heat gain.



Select windows with air leakage ratings of 0.3 cubic feet per minute or less.

In temperate climates with both heating and cooling seasons, select windows with both low U-values and low solar heat gain coefficient (SHGC) to maximize energy benefits.

Remember that new windows must be installed correctly to avoid air leaks around the frame. Look for a reputable, qualified installer.

Source: www1.eere.energy.gov

Categories: [Window blinds](#), [Window treatment](#)

 08/28/08 09:37:10 am,  [Leave a comment »](#)



Welcome to the Shades & Blinds Blog



by admin 

This blog is not for people who can't see. This blog is people who see too much! These people need tinting or window covering. I will not try to shade here a smile, so go ahead and write funny comments about Blinds and Shades...

The Shades & Blinds Blog covers these topics:

- **Motorized Shades:** Functionality is second to none with the choice of operating motorized blinds by remote control, switches, timers, AV and Home Automation Systems. Visit our site for Motorized Blinds, PowerRise Motorized Blinds and PowerRise with Platinum Blinds.
- **Shades New York:** Create a warm and inviting setting with our Applause honeycomb shades, or a subtle hue with our Designer Screen shades, Duette honeycomb, Provenance woven wood, Trio Convertible and Vignette Modern Roman Shades.
- **Window Blinds:** At The Shade Company we have blinds to suit the entire family. Kid's Room Design, custom Design, Kids Roller Vcolor, safety rollerLine, Country Woods, L shape double open, Simple White Blinds and Vertical Solutions.
- **Window Treatment:** Window treatments add refinement and style to otherwise dull, boring windows. Shutters and awnings decorate the outside of your house, while blinds, shades, cornices, trim and draperies enhance the inside appeal. Use the guides in this section to learn how to replace, install and decorate your windows.
- More to come...

Categories: [Window blinds](#)

 08/14/08 11:51:33 am,  [3 comments »](#)





THE SHADE COMPANY

FREE CONSULTATION

☎ 212.222.8288

CATEGORY: WINDOW TREATMENT

Save on your heating bill

by admin 

Windows

Windows can be one of your home's most attractive features. Windows provide views, daylighting, ventilation, and solar heating in the winter. Unfortunately, they can also account for 10% to 25% of your heating bill. During the summer, your air conditioner must work harder to cool hot air from sunny windows. Install **ENERGY STAR** windows and use curtains and shade to give your air conditioner and energy bill a break. If you live in the Sun Belt, look into new solar control spectrally selective windows, which can cut the cooling load by 10% to 15%.

If your home has single-pane windows, as almost half of U.S. homes do, consider replacing them. New doublepane windows with high-performance glass (e.g., low-e or spectrally selective) are available on the market. In colder climates, select windows that are gas filled with low emissivity (low-e) coatings on the glass to reduce heat loss. In warmer climates, select windows with spectrally selective coatings to reduce heat gain. If you are building a new home, you can offset some of the cost of installing more efficient windows because doing so allows you to buy smaller, less expensive heating and cooling equipment.

If you decide not to replace your windows, the simpler, less costly measures listed below can improve their performance.

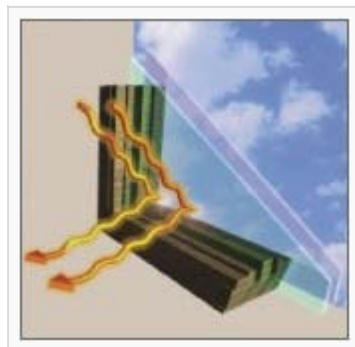

Cold Climate Windows Keep Heat In

Double-pane windows with low-e coating on the glass reflect heat back into the room

March 2011

Sun	Mon	Tue	Wed	Thu	Fri	Sat
		1	2	3	4	5
6	7	8	9	10	11	12
13	14	15	16	17	18	19
20	21	22	23	24	25	26
27	28	29	30	31		
<<	<					>
						>>

Blinds New York

This blog is not for people who can't see. This blog is people who see too much! These people need tinting or window covering. I will not try to shade here a smile, so go ahead and write funny comments about Blinds and Shades...

Recently

Archives

Categories

Latest comments

Search

All Words

during the winter months.

Cold-Climate Window Tips

You can use a heavy-duty, clear plastic sheet on a frame or tape clear plastic film to the inside of your window frames during the cold winter months. Remember, the plastic must be sealed tightly to the frame to help reduce infiltration.

Install tight-fitting, insulating window shades on windows that feel drafty after weatherizing.

Close your curtains and shades at night; open them during the day.

Keep windows on the south side of your house clean to let in the winter sun.

Install exterior or interior storm windows; storm windows can reduce heat loss through the windows by 25% to 50%. Storm windows should have weatherstripping at all moveable joints; be made of strong, durable materials; and have interlocking or overlapping joints. Low-e storm windows save even more energy.

Repair and weatherize your current storm windows, if necessary.

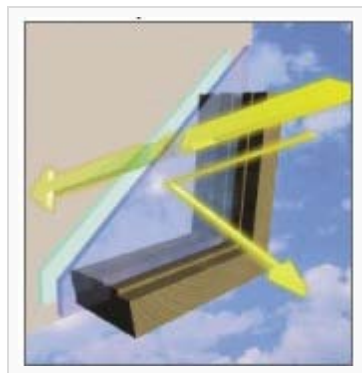

Warm Climate Windows Keep Heat Out

In the summertime, the sun shining through your windows heats up the room. Windows with spectrally selective coatings on the glass reflect some of the sunlight, keeping your rooms cooler.

Warm-Climate Window Tips

Install white window shades, drapes, or blinds to reflect heat away from the house.

Close curtains on south- and west-facing windows during the day.

Install awnings on south- and west-facing windows.

Apply sun-control or other reflective films on south-facing windows to reduce solar gain.

\$ Long-Term Savings Tip: Installing new, high-performance windows will improve your home's energy performance. While it may take many years for new windows to pay off in energy savings, the benefits of added comfort and improved aesthetics and functionality may make the investment worth it to you. Today, many new window technologies are available that are worth considering. Glazing materials (the glass part of the window) now come with a variety of selective coatings and other features; frames are available in aluminum, wood, vinyl, fiber glass, or combinations of these materials. Each type of glazing material and frame has advantages and disadvantages.

Shopping Tips for Windows

Look for the **ENERGY STAR**.

When you're shopping for new windows, look for the National Fenestration Rating Council label; it means the window's performance is certified.

Remember, the lower the U-value, the better the insulation. In colder climates, a U-value of 0.35 or below is recommended. These windows have at least double glazing and a low-e coating.

In warm climates, where summertime heat gain is the main concern, look for windows with double glazing and spectrally selective coatings that reduce heat gain.

Select windows with air leakage ratings of 0.3 cubic feet per minute or less.

In temperate climates with both heating and cooling seasons, select windows with both

Some Word
Entire phrase

Categories

All

Blinds new york

Motorized Shades

Shades new york

Window blinds

Window treatment

XML Feeds

RSS 2.0: Posts, Comments

Atom: Posts, Comments

[What is RSS?](#)





low U-values and low solar heat gain coefficient (SHGC) to maximize energy benefits.

Remember that new windows must be installed correctly to avoid air leaks around the frame. Look for a reputable, qualified installer.

Source: www1.eere.energy.gov

Categories: [Window blinds](#), [Window treatment](#)

 08/28/08 09:37:10 am,  [Leave a comment »](#)



Some YouTube Movies



by admin 

Let's start with funny idea to [Clean Window Blinds](#)

[How to Measure Roller Shades - outside mount](#)

[How to Make Your Own Curtains](#). Window Treatments in Easy Steps. Sewing the Tabs Together.

Categories: [Window treatment](#)

 08/25/08 05:11:58 pm,  [Leave a comment »](#)





THE SHADE
COMPANY

FREE CONSULTATION

☎ 212.222.8288

TAGS: SAFETY

Safety Tips For Solar Window Blinds For Your Children and Pets

by admin ✉

It is important for each of us to know how to raise awareness on the dangers of solar window blinds. Each year, many children are rushed to local emergency rooms due to injuries sustained when playing with the cords, or pulling on the cords that are part of window shades and window blinds. Pets have also been known to suffer from injuries due to these same types of cords.

As a parent, I feel that it is absolutely necessary to raise awareness of other parents and pet owners regarding this type of danger lurking in the home. Here, you will be taught how to know the dangers of window treatments.

The very first step that you can do to alert others on the dangers of window blinds is to observe these precautions in your own home. Make sure that all cords attached to solar window blinds are tied up highly. Not only will this help to avoid trips and potential falls, but it will divert the attention of children and animals from playing and pulling on the cords.

Window treatment in New York can install the best kind of window shades and window blinds together instruction on safety. Get the help of a window shades manufacturer in New York to give instruction on additional safety measures. By integrating safety in your own home, your visitors will see that you take the subject very seriously and may start to make the same changes and precautions in their homes, too.

The next thing that you can do to raise awareness about the dangers of cords on solar window blinds is to alert your local government. You should write letters to local legislators and those that work over your entire state. Persuade these individuals to make laws for daycare and educational facilities that require them to eliminate use of cords on window treatments.

In stating your case, it is important to offer alternatives for covering windows. This may include standard window treatments which can be purchased from a window blinds provider in New York.

To be honest, one of the last things that these officials have on their mind is safety with window blind cords. However, your letter will put this consideration out there.

If you have a knack for research, and can come up with some pretty strong evidence that solar window blinds pose potential dangers, you may elect to contact news

March 2011

Sun	Mon	Tue	Wed	Thu	Fri	Sat
		1	2	3	4	5
6	7	8	9	10	11	12
13	14	15	16	17	18	19
20	21	22	23	24	25	26
27	28	29	30	31		

<< < > >>

Blinds New York

This blog is not for people who can't see. This blog is people who see too much! These people need tinting or window covering. I will not try to shade here a smile, so go ahead and write funny comments about Blinds and Shades...

Recently

Archives

Categories

Latest comments



Search

All Words

reporters. You can choose those that work for local papers, or those that work on television. These individuals have the ability to get the word out quickly.

They are always looking for a great news story, and something like blind cords that seems to be no danger at all, but prove to be a danger can make for some bold headlines! Now, you know how to raise awareness of the dangers of solar window blinds!

Categories: [Window blinds](#), [Blinds new york](#) Tags: [safety](#), [shades new york](#), [window blinds](#), [window blinds new york](#), [window shades](#), [window shades new york](#), [window treatment new york](#), [window treatment nyc](#), [window treatments](#)

 12/30/08 03:49:56 pm,  [Leave a comment »](#)



Some Word
Entire phrase

Categories

All

Blinds new york

Motorized Shades

Shades new york

Window blinds

Window treatment

XML Feeds

RSS 2.0: [Posts](#), [Comments](#)

Atom: [Posts](#), [Comments](#)

[What is RSS?](#)





THE SHADE COMPANY

FREE CONSULTATION

☎ 212.222.8288

TAGS: SHADES NEW YORK

Safety Tips For Solar Window Blinds For Your Children and Pets

by admin ✉

It is important for each of us to know how to raise awareness on the dangers of solar window blinds. Each year, many children are rushed to local emergency rooms due to injuries sustained when playing with the cords, or pulling on the cords that are part of window shades and window blinds. Pets have also been known to suffer from injuries due to these same types of cords.

As a parent, I feel that it is absolutely necessary to raise awareness of other parents and pet owners regarding this type of danger lurking in the home. Here, you will be taught how to know the dangers of window treatments.

The very first step that you can do to alert others on the dangers of window blinds is to observe these precautions in your own home. Make sure that all cords attached to solar window blinds are tied up highly. Not only will this help to avoid trips and potential falls, but it will divert the attention of children and animals from playing and pulling on the cords.

Window treatment in New York can install the best kind of window shades and window blinds together instruction on safety. Get the help of a window shades manufacturer in New York to give instruction on additional safety measures. By integrating safety in your own home, your visitors will see that you take the subject very seriously and may start to make the same changes and precautions in their homes, too.

The next thing that you can do to raise awareness about the dangers of cords on solar window blinds is to alert your local government. You should write letters to local legislators and those that work over your entire state. Persuade these individuals to make laws for daycare and educational facilities that require them to eliminate use of cords on window treatments.

In stating your case, it is important to offer alternatives for covering windows. This may include standard window treatments which can be purchased from a window blinds provider in New York.

To be honest, one of the last things that these officials have on their mind is safety with window blind cords. However, your letter will put this consideration out there.

If you have a knack for research, and can come up with some pretty strong evidence that solar window blinds pose potential dangers, you may elect to contact news

March 2011

Sun	Mon	Tue	Wed	Thu	Fri	Sat
		1	2	3	4	5
6	7	8	9	10	11	12
13	14	15	16	17	18	19
20	21	22	23	24	25	26
27	28	29	30	31		

<< < > >>

Blinds New York

This blog is not for people who can't see. This blog is people who see too much! These people need tinting or window covering. I will not try to shade here a smile, so go ahead and write funny comments about Blinds and Shades...

Recently

Archives

Categories

Latest comments



Search

All Words

reporters. You can choose those that work for local papers, or those that work on television. These individuals have the ability to get the word out quickly.

They are always looking for a great news story, and something like blind cords that seems to be no danger at all, but prove to be a danger can make for some bold headlines! Now, you know how to raise awareness of the dangers of solar window blinds!

Categories: [Window blinds](#), [Blinds new york](#) Tags: [safety](#), [shades new york](#), [window blinds](#), [window blinds new york](#), [window shades](#), [window shades new york](#), [window treatment new york](#), [window treatment nyc](#), [window treatments](#)

 12/30/08 03:49:56 pm,  [Leave a comment »](#)



Some Word
Entire phrase

Categories

All

[Blinds new york](#)

[Motorized Shades](#)

[Shades new york](#)

[Window blinds](#)

[Window treatment](#)

XML Feeds

RSS 2.0: [Posts](#), [Comments](#)
Atom: [Posts](#), [Comments](#)

[What is RSS?](#)





THE SHADE COMPANY

FREE CONSULTATION

☎ 212.222.8288

TAGS: WINDOW BLINDS

Safety Tips For Solar Window Blinds For Your Children and Pets

by admin ✉

It is important for each of us to know how to raise awareness on the dangers of solar window blinds. Each year, many children are rushed to local emergency rooms due to injuries sustained when playing with the cords, or pulling on the cords that are part of window shades and window blinds. Pets have also been known to suffer from injuries due to these same types of cords.

As a parent, I feel that it is absolutely necessary to raise awareness of other parents and pet owners regarding this type of danger lurking in the home. Here, you will be taught how to know the dangers of window treatments.

The very first step that you can do to alert others on the dangers of window blinds is to observe these precautions in your own home. Make sure that all cords attached to solar window blinds are tied up highly. Not only will this help to avoid trips and potential falls, but it will divert the attention of children and animals from playing and pulling on the cords.

Window treatment in New York can install the best kind of window shades and window blinds together instruction on safety. Get the help of a window shades manufacturer in New York to give instruction on additional safety measures. By integrating safety in your own home, your visitors will see that you take the subject very seriously and may start to make the same changes and precautions in their homes, too.

The next thing that you can do to raise awareness about the dangers of cords on solar window blinds is to alert your local government. You should write letters to local legislators and those that work over your entire state. Persuade these individuals to make laws for daycare and educational facilities that require them to eliminate use of cords on window treatments.

In stating your case, it is important to offer alternatives for covering windows. This may include standard window treatments which can be purchased from a window blinds provider in New York.

To be honest, one of the last things that these officials have on their mind is safety with window blind cords. However, your letter will put this consideration out there.

If you have a knack for research, and can come up with some pretty strong evidence that solar window blinds pose potential dangers, you may elect to contact news

March 2011

Sun	Mon	Tue	Wed	Thu	Fri	Sat
		1	2	3	4	5
6	7	8	9	10	11	12
13	14	15	16	17	18	19
20	21	22	23	24	25	26
27	28	29	30	31		

<< < > >>

Blinds New York

This blog is not for people who can't see. This blog is people who see too much! These people need tinting or window covering. I will not try to shade here a smile, so go ahead and write funny comments about Blinds and Shades...

Recently

Archives

Categories

Latest comments



Search

All Words

reporters. You can choose those that work for local papers, or those that work on television. These individuals have the ability to get the word out quickly.

They are always looking for a great news story, and something like blind cords that seems to be no danger at all, but prove to be a danger can make for some bold headlines! Now, you know how to raise awareness of the dangers of solar window blinds!

Categories: [Window blinds](#), [Blinds new york](#) Tags: [safety](#), [shades new york](#), [window blinds](#), [window blinds new york](#), [window shades](#), [window shades new york](#), [window treatment new york](#), [window treatment nyc](#), [window treatments](#)

 12/30/08 03:49:56 pm,  [Leave a comment »](#)



Some Word
Entire phrase

Categories

All

[Blinds new york](#)

[Motorized Shades](#)

[Shades new york](#)

[Window blinds](#)

[Window treatment](#)

XML Feeds

RSS 2.0: [Posts](#), [Comments](#)
Atom: [Posts](#), [Comments](#)

[What is RSS?](#)





THE SHADE COMPANY

FREE CONSULTATION

☎ 212.222.8288

TAGS: WINDOW BLINDS NEW YORK

Safety Tips For Solar Window Blinds For Your Children and Pets

by admin ✉

It is important for each of us to know how to raise awareness on the dangers of solar window blinds. Each year, many children are rushed to local emergency rooms due to injuries sustained when playing with the cords, or pulling on the cords that are part of window shades and window blinds. Pets have also been known to suffer from injuries due to these same types of cords.

As a parent, I feel that it is absolutely necessary to raise awareness of other parents and pet owners regarding this type of danger lurking in the home. Here, you will be taught how to know the dangers of window treatments.

The very first step that you can do to alert others on the dangers of window blinds is to observe these precautions in your own home. Make sure that all cords attached to solar window blinds are tied up highly. Not only will this help to avoid trips and potential falls, but it will divert the attention of children and animals from playing and pulling on the cords.

Window treatment in New York can install the best kind of window shades and window blinds together instruction on safety. Get the help of a window shades manufacturer in New York to give instruction on additional safety measures. By integrating safety in your own home, your visitors will see that you take the subject very seriously and may start to make the same changes and precautions in their homes, too.

The next thing that you can do to raise awareness about the dangers of cords on solar window blinds is to alert your local government. You should write letters to local legislators and those that work over your entire state. Persuade these individuals to make laws for daycare and educational facilities that require them to eliminate use of cords on window treatments.

In stating your case, it is important to offer alternatives for covering windows. This may include standard window treatments which can be purchased from a window blinds provider in New York.

To be honest, one of the last things that these officials have on their mind is safety with window blind cords. However, your letter will put this consideration out there.

If you have a knack for research, and can come up with some pretty strong evidence that solar window blinds pose potential dangers, you may elect to contact news

March 2011

Sun	Mon	Tue	Wed	Thu	Fri	Sat
		1	2	3	4	5
6	7	8	9	10	11	12
13	14	15	16	17	18	19
20	21	22	23	24	25	26
27	28	29	30	31		

<< < > >>

Blinds New York

This blog is not for people who can't see. This blog is people who see too much! These people need tinting or window covering. I will not try to shade here a smile, so go ahead and write funny comments about Blinds and Shades...

Recently

Archives

Categories

Latest comments



Search

All Words

reporters. You can choose those that work for local papers, or those that work on television. These individuals have the ability to get the word out quickly.

They are always looking for a great news story, and something like blind cords that seems to be no danger at all, but prove to be a danger can make for some bold headlines! Now, you know how to raise awareness of the dangers of solar window blinds!

Categories: [Window blinds](#), [Blinds new york](#) Tags: [safety](#), [shades new york](#), [window blinds](#), [window blinds new york](#), [window shades](#), [window shades new york](#), [window treatment new york](#), [window treatment nyc](#), [window treatments](#)

 12/30/08 03:49:56 pm,  [Leave a comment »](#)



Some Word
Entire phrase

Categories

All

Blinds new york

Motorized Shades

Shades new york

Window blinds

Window treatment

XML Feeds

RSS 2.0: [Posts](#), [Comments](#)

Atom: [Posts](#), [Comments](#)

[What is RSS?](#)





THE SHADE COMPANY

FREE CONSULTATION

☎ 212.222.8288

TAGS: WINDOW SHADES

Safety Tips For Solar Window Blinds For Your Children and Pets

by admin ✉

It is important for each of us to know how to raise awareness on the dangers of solar window blinds. Each year, many children are rushed to local emergency rooms due to injuries sustained when playing with the cords, or pulling on the cords that are part of window shades and window blinds. Pets have also been known to suffer from injuries due to these same types of cords.

As a parent, I feel that it is absolutely necessary to raise awareness of other parents and pet owners regarding this type of danger lurking in the home. Here, you will be taught how to know the dangers of window treatments.

The very first step that you can do to alert others on the dangers of window blinds is to observe these precautions in your own home. Make sure that all cords attached to solar window blinds are tied up highly. Not only will this help to avoid trips and potential falls, but it will divert the attention of children and animals from playing and pulling on the cords.

Window treatment in New York can install the best kind of window shades and window blinds together instruction on safety. Get the help of a window shades manufacturer in New York to give instruction on additional safety measures. By integrating safety in your own home, your visitors will see that you take the subject very seriously and may start to make the same changes and precautions in their homes, too.

The next thing that you can do to raise awareness about the dangers of cords on solar window blinds is to alert your local government. You should write letters to local legislators and those that work over your entire state. Persuade these individuals to make laws for daycare and educational facilities that require them to eliminate use of cords on window treatments.

In stating your case, it is important to offer alternatives for covering windows. This may include standard window treatments which can be purchased from a window blinds provider in New York.

To be honest, one of the last things that these officials have on their mind is safety with window blind cords. However, your letter will put this consideration out there.

If you have a knack for research, and can come up with some pretty strong evidence that solar window blinds pose potential dangers, you may elect to contact news

March 2011

Sun	Mon	Tue	Wed	Thu	Fri	Sat	
		1	2	3	4	5	
6	7	8	9	10	11	12	
13	14	15	16	17	18	19	
20	21	22	23	24	25	26	
27	28	29	30	31			
<<	<					>	>>

Blinds New York

This blog is not for people who can't see. This blog is people who see too much! These people need tinting or window covering. I will not try to shade here a smile, so go ahead and write funny comments about Blinds and Shades...

Recently

Archives

Categories

Latest comments



Search

All Words

reporters. You can choose those that work for local papers, or those that work on television. These individuals have the ability to get the word out quickly.

They are always looking for a great news story, and something like blind cords that seems to be no danger at all, but prove to be a danger can make for some bold headlines! Now, you know how to raise awareness of the dangers of solar window blinds!

Categories: [Window blinds](#), [Blinds new york](#) Tags: [safety](#), [shades new york](#), [window blinds](#), [window blinds new york](#), [window shades](#), [window shades new york](#), [window treatment new york](#), [window treatment nyc](#), [window treatments](#)

 12/30/08 03:49:56 pm,  [Leave a comment »](#)



Some Word
Entire phrase

Categories

All

[Blinds new york](#)

[Motorized Shades](#)

[Shades new york](#)

[Window blinds](#)

[Window treatment](#)

XML Feeds

RSS 2.0: [Posts](#), [Comments](#)
Atom: [Posts](#), [Comments](#)

[What is RSS?](#)





THE SHADE COMPANY

FREE CONSULTATION

☎ 212.222.8288

TAGS: WINDOW SHADES NEW YORK

Safety Tips For Solar Window Blinds For Your Children and Pets

by admin ✉

It is important for each of us to know how to raise awareness on the dangers of solar window blinds. Each year, many children are rushed to local emergency rooms due to injuries sustained when playing with the cords, or pulling on the cords that are part of window shades and window blinds. Pets have also been known to suffer from injuries due to these same types of cords.

As a parent, I feel that it is absolutely necessary to raise awareness of other parents and pet owners regarding this type of danger lurking in the home. Here, you will be taught how to know the dangers of window treatments.

The very first step that you can do to alert others on the dangers of window blinds is to observe these precautions in your own home. Make sure that all cords attached to solar window blinds are tied up highly. Not only will this help to avoid trips and potential falls, but it will divert the attention of children and animals from playing and pulling on the cords.

Window treatment in New York can install the best kind of window shades and window blinds together instruction on safety. Get the help of a window shades manufacturer in New York to give instruction on additional safety measures. By integrating safety in your own home, your visitors will see that you take the subject very seriously and may start to make the same changes and precautions in their homes, too.

The next thing that you can do to raise awareness about the dangers of cords on solar window blinds is to alert your local government. You should write letters to local legislators and those that work over your entire state. Persuade these individuals to make laws for daycare and educational facilities that require them to eliminate use of cords on window treatments.

In stating your case, it is important to offer alternatives for covering windows. This may include standard window treatments which can be purchased from a window blinds provider in New York.

To be honest, one of the last things that these officials have on their mind is safety with window blind cords. However, your letter will put this consideration out there.

If you have a knack for research, and can come up with some pretty strong evidence that solar window blinds pose potential dangers, you may elect to contact news

March 2011

Sun	Mon	Tue	Wed	Thu	Fri	Sat
		1	2	3	4	5
6	7	8	9	10	11	12
13	14	15	16	17	18	19
20	21	22	23	24	25	26
27	28	29	30	31		

<< < > >>

Blinds New York

This blog is not for people who can't see. This blog is people who see too much! These people need tinting or window covering. I will not try to shade here a smile, so go ahead and write funny comments about Blinds and Shades...

Recently

Archives

Categories

Latest comments



Search

All Words

reporters. You can choose those that work for local papers, or those that work on television. These individuals have the ability to get the word out quickly.

They are always looking for a great news story, and something like blind cords that seems to be no danger at all, but prove to be a danger can make for some bold headlines! Now, you know how to raise awareness of the dangers of solar window blinds!

Categories: [Window blinds](#), [Blinds new york](#) Tags: [safety](#), [shades new york](#), [window blinds](#), [window blinds new york](#), [window shades](#), [window shades new york](#), [window treatment new york](#), [window treatment nyc](#), [window treatments](#)

 12/30/08 03:49:56 pm,  [Leave a comment »](#)



Some Word
Entire phrase

Categories

All

[Blinds new york](#)

[Motorized Shades](#)

[Shades new york](#)

[Window blinds](#)

[Window treatment](#)

XML Feeds

RSS 2.0: [Posts](#), [Comments](#)
Atom: [Posts](#), [Comments](#)

[What is RSS?](#)





THE SHADE
COMPANY

FREE CONSULTATION

☎ 212.222.8288

TAGS: WINDOW TREATMENT NEW YORK

Safety Tips For Solar Window Blinds For Your Children and Pets

by admin ✉

It is important for each of us to know how to raise awareness on the dangers of solar window blinds. Each year, many children are rushed to local emergency rooms due to injuries sustained when playing with the cords, or pulling on the cords that are part of window shades and window blinds. Pets have also been known to suffer from injuries due to these same types of cords.

As a parent, I feel that it is absolutely necessary to raise awareness of other parents and pet owners regarding this type of danger lurking in the home. Here, you will be taught how to know the dangers of window treatments.

The very first step that you can do to alert others on the dangers of window blinds is to observe these precautions in your own home. Make sure that all cords attached to solar window blinds are tied up highly. Not only will this help to avoid trips and potential falls, but it will divert the attention of children and animals from playing and pulling on the cords.

Window treatment in New York can install the best kind of window shades and window blinds together instruction on safety. Get the help of a window shades manufacturer in New York to give instruction on additional safety measures. By integrating safety in your own home, your visitors will see that you take the subject very seriously and may start to make the same changes and precautions in their homes, too.

The next thing that you can do to raise awareness about the dangers of cords on solar window blinds is to alert your local government. You should write letters to local legislators and those that work over your entire state. Persuade these individuals to make laws for daycare and educational facilities that require them to eliminate use of cords on window treatments.

In stating your case, it is important to offer alternatives for covering windows. This may include standard window treatments which can be purchased from a window blinds provider in New York.

To be honest, one of the last things that these officials have on their mind is safety with window blind cords. However, your letter will put this consideration out there.

If you have a knack for research, and can come up with some pretty strong evidence that solar window blinds pose potential dangers, you may elect to contact news

March 2011

Sun	Mon	Tue	Wed	Thu	Fri	Sat	
		1	2	3	4	5	
6	7	8	9	10	11	12	
13	14	15	16	17	18	19	
20	21	22	23	24	25	26	
27	28	29	30	31			
<<	<					>	>>

Blinds New York

This blog is not for people who can't see. This blog is people who see too much! These people need tinting or window covering. I will not try to shade here a smile, so go ahead and write funny comments about Blinds and Shades...

Recently

Archives

Categories

Latest comments



Search

All Words

reporters. You can choose those that work for local papers, or those that work on television. These individuals have the ability to get the word out quickly.

They are always looking for a great news story, and something like blind cords that seems to be no danger at all, but prove to be a danger can make for some bold headlines! Now, you know how to raise awareness of the dangers of solar window blinds!

Categories: [Window blinds](#), [Blinds new york](#) Tags: [safety](#), [shades new york](#), [window blinds](#), [window blinds new york](#), [window shades](#), [window shades new york](#), [window treatment new york](#), [window treatment nyc](#), [window treatments](#)

 12/30/08 03:49:56 pm,  [Leave a comment »](#)



Some Word
Entire phrase

Categories

All

[Blinds new york](#)

[Motorized Shades](#)

[Shades new york](#)

[Window blinds](#)

[Window treatment](#)

XML Feeds

RSS 2.0: [Posts](#), [Comments](#)
Atom: [Posts](#), [Comments](#)

[What is RSS?](#)





THE SHADE
COMPANY

FREE CONSULTATION

☎ 212.222.8288

TAGS: WINDOW TREATMENT NYC

Safety Tips For Solar Window Blinds For Your Children and Pets

by admin ✉

It is important for each of us to know how to raise awareness on the dangers of solar window blinds. Each year, many children are rushed to local emergency rooms due to injuries sustained when playing with the cords, or pulling on the cords that are part of window shades and window blinds. Pets have also been known to suffer from injuries due to these same types of cords.

As a parent, I feel that it is absolutely necessary to raise awareness of other parents and pet owners regarding this type of danger lurking in the home. Here, you will be taught how to know the dangers of window treatments.

The very first step that you can do to alert others on the dangers of window blinds is to observe these precautions in your own home. Make sure that all cords attached to solar window blinds are tied up highly. Not only will this help to avoid trips and potential falls, but it will divert the attention of children and animals from playing and pulling on the cords.

Window treatment in New York can install the best kind of window shades and window blinds together instruction on safety. Get the help of a window shades manufacturer in New York to give instruction on additional safety measures. By integrating safety in your own home, your visitors will see that you take the subject very seriously and may start to make the same changes and precautions in their homes, too.

The next thing that you can do to raise awareness about the dangers of cords on solar window blinds is to alert your local government. You should write letters to local legislators and those that work over your entire state. Persuade these individuals to make laws for daycare and educational facilities that require them to eliminate use of cords on window treatments.

In stating your case, it is important to offer alternatives for covering windows. This may include standard window treatments which can be purchased from a window blinds provider in New York.

To be honest, one of the last things that these officials have on their mind is safety with window blind cords. However, your letter will put this consideration out there.

If you have a knack for research, and can come up with some pretty strong evidence that solar window blinds pose potential dangers, you may elect to contact news

March 2011

Sun	Mon	Tue	Wed	Thu	Fri	Sat
		1	2	3	4	5
6	7	8	9	10	11	12
13	14	15	16	17	18	19
20	21	22	23	24	25	26
27	28	29	30	31		
<<	<					>>

Blinds New York

This blog is not for people who can't see. This blog is people who see too much! These people need tinting or window covering. I will not try to shade here a smile, so go ahead and write funny comments about Blinds and Shades...

Recently

Archives

Categories

Latest comments



Search

All Words

reporters. You can choose those that work for local papers, or those that work on television. These individuals have the ability to get the word out quickly.

They are always looking for a great news story, and something like blind cords that seems to be no danger at all, but prove to be a danger can make for some bold headlines! Now, you know how to raise awareness of the dangers of solar window blinds!

Categories: [Window blinds](#), [Blinds new york](#) Tags: [safety](#), [shades new york](#), [window blinds](#), [window blinds new york](#), [window shades](#), [window shades new york](#), [window treatment new york](#), [window treatment nyc](#), [window treatments](#)

 12/30/08 03:49:56 pm,  [Leave a comment »](#)



Some Word
Entire phrase

Categories

All

[Blinds new york](#)

[Motorized Shades](#)

[Shades new york](#)

[Window blinds](#)

[Window treatment](#)

XML Feeds

RSS 2.0: [Posts](#), [Comments](#)
Atom: [Posts](#), [Comments](#)

[What is RSS?](#)





THE SHADE COMPANY

FREE CONSULTATION

☎ 212.222.8288

TAGS: WINDOW TREATMENTS

Safety Tips For Solar Window Blinds For Your Children and Pets

by admin ✉

It is important for each of us to know how to raise awareness on the dangers of solar window blinds. Each year, many children are rushed to local emergency rooms due to injuries sustained when playing with the cords, or pulling on the cords that are part of window shades and window blinds. Pets have also been known to suffer from injuries due to these same types of cords.

As a parent, I feel that it is absolutely necessary to raise awareness of other parents and pet owners regarding this type of danger lurking in the home. Here, you will be taught how to know the dangers of window treatments.

The very first step that you can do to alert others on the dangers of window blinds is to observe these precautions in your own home. Make sure that all cords attached to solar window blinds are tied up highly. Not only will this help to avoid trips and potential falls, but it will divert the attention of children and animals from playing and pulling on the cords.

Window treatment in New York can install the best kind of window shades and window blinds together instruction on safety. Get the help of a window shades manufacturer in New York to give instruction on additional safety measures. By integrating safety in your own home, your visitors will see that you take the subject very seriously and may start to make the same changes and precautions in their homes, too.

The next thing that you can do to raise awareness about the dangers of cords on solar window blinds is to alert your local government. You should write letters to local legislators and those that work over your entire state. Persuade these individuals to make laws for daycare and educational facilities that require them to eliminate use of cords on window treatments.

In stating your case, it is important to offer alternatives for covering windows. This may include standard window treatments which can be purchased from a window blinds provider in New York.

To be honest, one of the last things that these officials have on their mind is safety with window blind cords. However, your letter will put this consideration out there.

If you have a knack for research, and can come up with some pretty strong evidence that solar window blinds pose potential dangers, you may elect to contact news

March 2011

Sun	Mon	Tue	Wed	Thu	Fri	Sat
		1	2	3	4	5
6	7	8	9	10	11	12
13	14	15	16	17	18	19
20	21	22	23	24	25	26
27	28	29	30	31		

<< < > >>

Blinds New York

This blog is not for people who can't see. This blog is people who see too much! These people need tinting or window covering. I will not try to shade here a smile, so go ahead and write funny comments about Blinds and Shades...

Recently

Archives

Categories

Latest comments



Search

All Words

reporters. You can choose those that work for local papers, or those that work on television. These individuals have the ability to get the word out quickly.

They are always looking for a great news story, and something like blind cords that seems to be no danger at all, but prove to be a danger can make for some bold headlines! Now, you know how to raise awareness of the dangers of solar window blinds!

Categories: [Window blinds](#), [Blinds new york](#) Tags: [safety](#), [shades new york](#), [window blinds](#), [window blinds new york](#), [window shades](#), [window shades new york](#), [window treatment new york](#), [window treatment nyc](#), [window treatments](#)

 12/30/08 03:49:56 pm,  [Leave a comment »](#)



Some Word
Entire phrase

Categories

All

Blinds new york

Motorized Shades

Shades new york

Window blinds

Window treatment

XML Feeds

RSS 2.0: [Posts](#), [Comments](#)

Atom: [Posts](#), [Comments](#)

[What is RSS?](#)





FREE CONSULTATION

 212.222.8288

Save on your heating bill

by admin 

Windows

Windows can be one of your home's most attractive features. Windows provide views, daylighting, ventilation, and solar heating in the winter. Unfortunately, they can also account for 10% to 25% of your heating bill. During the summer, your air conditioner must work harder to cool hot air from sunny windows. Install **ENERGY STAR** windows and use curtains and shade to give your air conditioner and energy bill a break. If you live in the Sun Belt, look into new solar control spectrally selective windows, which can cut the cooling load by 10% to 15%.

If your home has single-pane windows, as almost half of U.S. homes do, consider replacing them. New doublepane windows with high-performance glass (e.g., low-e or spectrally selective) are available on the market. In colder climates, select windows that are gas filled with low emissivity (low-e) coatings on the glass to reduce heat loss. In warmer climates, select windows with spectrally selective coatings to reduce heat gain. If you are building a new home, you can offset some of the cost of installing more efficient windows because doing so allows you to buy smaller, less expensive heating and cooling equipment.

If you decide not to replace your windows, the simpler, less costly measures listed below can improve their performance.

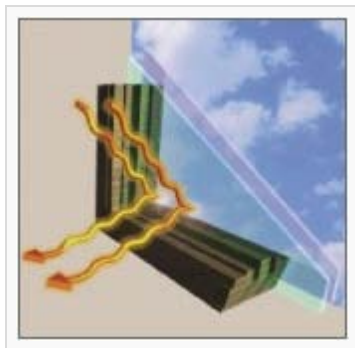

Cold Climate Windows Keep Heat In

Double-pane windows with low-e coating on the glass reflect heat back into the room during the winter months.

March 2011

Sun	Mon	Tue	Wed	Thu	Fri	Sat
		1	2	3	4	5
6	7	8	9	10	11	12
13	14	15	16	17	18	19
20	21	22	23	24	25	26
27	28	29	30	31		
<< <			> >>			

Blinds New York

This blog is not for people who can't see. This blog is people who see too much! These people need tinting or window covering. I will not try to shade here a smile, so go ahead and write funny comments about Blinds and Shades...

[Recently](#)
[Archives](#)
[Categories](#)
[Latest comments](#)

Search

Cold-Climate Window Tips

You can use a heavy-duty, clear plastic sheet on a frame or tape clear plastic film to the inside of your window frames during the cold winter months. Remember, the plastic must be sealed tightly to the frame to help reduce infiltration.

Install tight-fitting, insulating window shades on windows that feel drafty after weatherizing.

Close your curtains and shades at night; open them during the day.

Keep windows on the south side of your house clean to let in the winter sun.

Install exterior or interior storm windows; storm windows can reduce heat loss through the windows by 25% to 50%. Storm windows should have weatherstripping at all moveable joints; be made of strong, durable materials; and have interlocking or overlapping joints. Low-e storm windows save even more energy.

Repair and weatherize your current storm windows, if necessary.

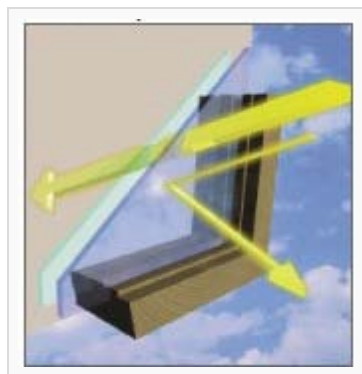

Warm Climate Windows Keep Heat Out

In the summertime, the sun shining through your windows heats up the room. Windows with spectrally selective coatings on the glass reflect some of the sunlight, keeping your rooms cooler.

Warm-Climate Window Tips

Install white window shades, drapes, or blinds to reflect heat away from the house.

Close curtains on south- and west-facing windows during the day.

Install awnings on south- and west-facing windows.

Apply sun-control or other reflective films on south-facing windows to reduce solar gain.

\$ Long-Term Savings Tip: Installing new, high-performance windows will improve your home's energy performance. While it may take many years for new windows to pay off in energy savings, the benefits of added comfort and improved aesthetics and functionality may make the investment worth it to you. Today, many new window technologies are available that are worth considering. Glazing materials (the glass part of the window) now come with a variety of selective coatings and other features; frames are available in aluminum, wood, vinyl, fiber glass, or combinations of these materials. Each type of glazing material and frame has advantages and disadvantages.

Shopping Tips for Windows

Look for the **ENERGY STAR**.

When you're shopping for new windows, look for the National Fenestration Rating Council label; it means the window's performance is certified.

Remember, the lower the U-value, the better the insulation. In colder climates, a U-value of 0.35 or below is recommended. These windows have at least double glazing and a low-e coating.

In warm climates, where summertime heat gain is the main concern, look for windows with double glazing and spectrally selective coatings that reduce heat gain.

Select windows with air leakage ratings of 0.3 cubic feet per minute or less.

In temperate climates with both heating and cooling seasons, select windows with both low U-values and low solar heat gain coefficient (SHGC) to maximize energy benefits.

Entire phrase

Categories

All

Blinds new york

Motorized Shades

Shades new york

Window blinds

Window treatment

XML Feeds

RSS 2.0: [Posts](#), [Comments](#)

Atom: [Posts](#), [Comments](#)



[What is RSS?](#)



Remember that new windows must be installed correctly to avoid air leaks around the frame. Look for a reputable, qualified installer.

Source: www1.eere.energy.gov

Categories: [Window blinds](#), [Window treatment](#)

 08/28/08 09:37:10 am,  [Leave a comment »](#)



Feedback awaiting moderation

This post has 32 feedbacks awaiting moderation...

 [Comment feed for this post](#)

Leave a comment

Name:

Email:

Your email address will not be revealed on this site.

Website:

Your URL will be displayed.

Comment
text:

Options: **Auto-BR** (Line breaks become
)
Remember me (Name, email & website)
Allow message form (Allow users to contact you through a message form
(your email will not be revealed.)

Blinds New York

By The Shade Company

Blinds NY

Home

About The Shade Company

Contact

Log in



THE SHADE COMPANY

FREE CONSULTATION

212.222.8288

SEND AN EMAIL MESSAGE

To: admin

From: Your name.

Email: Your email address. (Will not be displayed on this site.)

Subject: Subject of email message.

Message:

Plain text only.

March 2011

Sun	Mon	Tue	Wed	Thu	Fri	Sat
		1	2	3	4	5
6	7	8	9	10	11	12
13	14	15	16	17	18	19
20	21	22	23	24	25	26
27	28	29	30	31		

<< < > >>

Blinds New York

This blog is not for people who can't see. This blog is people who see too much! These people need tinting or window covering. I will not try to shade here a smile, so go ahead and write funny comments about Blinds and Shades...

Recently

Archives

Categories

Latest comments

Search

All Words

Some Word
Entire phrase

Categories

All

Blinds new york

Motorized Shades

Shades new york

Window blinds

Window treatment

XML Feeds

RSS 2.0: [Posts](#), [Comments](#)
Atom: [Posts](#), [Comments](#)

[What is RSS?](#)





Some YouTube Movies

by admin

Let's start with funny idea to [Clean Window Blinds](#)

[How to Measure Roller Shades - outside mount](#)

[How to Make Your Own Curtains.](#) Window Treatments in Easy Steps. Sewing the Tabs Together.

Categories: [Window treatment](#)

08/25/08 05:11:58 pm, [Leave a comment »](#)



Feedback awaiting moderation

This post has 41 feedbacks awaiting moderation...

March 2011

Sun	Mon	Tue	Wed	Thu	Fri	Sat	
		1	2	3	4	5	
6	7	8	9	10	11	12	
13	14	15	16	17	18	19	
20	21	22	23	24	25	26	
27	28	29	30	31			
<<	<					>	>>

Blinds New York

This blog is not for people who can't see. This blog is people who see too much! These people need tinting or window covering. I will not try to shade here a smile, so go ahead and write funny comments about Blinds and Shades...

Recently

Archives

Categories

Latest comments

Search

All Words
Some Word

Blinds New York

By The Shade Company

Blinds NY

Home

About The Shade Company

Contact

Log in



THE SHADE COMPANY

FREE CONSULTATION

212.222.8288

SEND AN EMAIL MESSAGE

To: admin

From:

Your name.

Email:

not be displayed on this site.)

Your email address. (Will

Subject:

message.

Subject of email

Message:

Plain text only.

March 2011

Sun	Mon	Tue	Wed	Thu	Fri	Sat
		1	2	3	4	5
6	7	8	9	10	11	12
13	14	15	16	17	18	19
20	21	22	23	24	25	26
27	28	29	30	31		

<< < > >>

Blinds New York

This blog is not for people who can't see. This blog is people who see too much! These people need tinting or window covering. I will not try to shade here a smile, so go ahead and write funny comments about Blinds and Shades...

Recently

Archives

Categories

Latest comments

Search

All Words

Some Word
Entire phrase

Categories

All

Blinds new york

Motorized Shades

Shades new york

Window blinds

Window treatment

XML Feeds

RSS 2.0: [Posts](#), [Comments](#)
Atom: [Posts](#), [Comments](#)

[What is RSS?](#)





Welcome to the Shades & Blinds Blog

by admin

This blog is not for people who can't see. This blog is people who see too much! These people need tinting or window covering. I will not try to shade here a smile, so go ahead and write funny comments about Blinds and Shades...

The Shades & Blinds Blog covers these topics:

- **Motorized Shades:** Functionality is second to none with the choice of operating motorized blinds by remote control, switches, timers, AV and Home Automation Systems. Visit our site for Motorized Blinds, PowerRise Motorized Blinds and PowerRise with Platinum Blinds.
- **Shades New York:** Create a warm and inviting setting with our Applause honeycomb shades, or a subtle hue with our Designer Screen shades, Duette honeycomb, Provenance woven wood, Trio Convertible and Vignette Modern Roman Shades.
- **Window Blinds:** At The Shade Company we have blinds to suit the entire family. Kid's Room Design, custom Design, Kids Roller Vcolor, safety rollerLine, Country Woods, L shape double open, Simple White Blinds and Vertical Solutions.
- **Window Treatment:** Window treatments add refinement and style to otherwise dull, boring windows. Shutters and awnings decorate the outside of your house, while blinds, shades, cornices, trim and draperies enhance the inside appeal. Use the guides in this section to learn how to replace, install and decorate your windows.
- More to come...

Categories: [Window blinds](#)

08/14/08 11:51:33 am, 3 comments »

3 comments

Comment from: Milo Darnello [Visitor] · <http://www.motorizedblinds.co.uk>

Very nice blog, although I live in the UK I thought I might post something regarding the safety aspect of electric blinds. Many people are unaware that cord operated blinds are a safety hazzard where young children are concerned, sadly there are too many cases where children have got tangled in the cords. Electric blinds or shutters

March 2011

Sun	Mon	Tue	Wed	Thu	Fri	Sat
		1	2	3	4	5
6	7	8	9	10	11	12
13	14	15	16	17	18	19
20	21	22	23	24	25	26
27	28	29	30	31		
<< <			> >>			

Blinds New York

This blog is not for people who can't see. This blog is people who see too much! These people need tinting or window covering. I will not try to shade here a smile, so go ahead and write funny comments about Blinds and Shades...

Recently

Archives

Categories

Latest comments

Search

All Words
Some Word

do not have this problem so are therefore safer, yes you may pay a little more but the benefits are 100 fold.

Kindest regards Hillary.

03/04/09 @ 13:59

Comment from: Cayla [Visitor] · <http://www.pdfqueen.com>

Made my life easier...thanks

12/13/09 @ 10:41

Comment from: Dillon Hardisty [Visitor] · <http://unaico-sitetalk.net>

You got great honest points here. I done a search on the issue and learnt most peoples will agree with your blog.

02/28/10 @ 13:43

This post has 20 feedbacks awaiting moderation...

 [Comment feed for this post](#)

Leave a comment

Name:

Email:

Your email address will not be revealed on this site.

Website:

Your URL will be displayed.

Comment
text:

Options:

Auto-BR (Line breaks become
)

Remember me (Name, email & website)

Allow message form (Allow users to contact you through a message form
(your email will not be revealed.)

Entire phrase

Categories

All

Blinds new york

Motorized Shades

Shades new york

Window blinds

Window treatment

XML Feeds

RSS 2.0: [Posts](#), [Comments](#)

Atom: [Posts](#), [Comments](#)

[What is RSS?](#)



Blinds New York

By The Shade Company

Blinds NY

[Home](#)

[About The Shade Company](#)

[Contact](#)

[Log in](#)



THE SHADE COMPANY

FREE CONSULTATION

☎ 212.222.8288

SEND AN EMAIL MESSAGE

To: admin

From:

Your name.

Email:

not be displayed on this site.)

Your email address. (Will

Subject:

message.

Subject of email

Message:

Plain text only.

March 2011

Sun	Mon	Tue	Wed	Thu	Fri	Sat
		1	2	3	4	5
6	7	8	9	10	11	12
13	14	15	16	17	18	19
20	21	22	23	24	25	26
27	28	29	30	31		

<< < > >>

Blinds New York

This blog is not for people who can't see. This blog is people who see too much! These people need tinting or window covering. I will not try to shade here a smile, so go ahead and write funny comments about Blinds and Shades...

Recently

Archives

Categories

Latest comments

Search

All Words

Some Word
Entire phrase

Categories

All

Blinds new york

Motorized Shades

Shades new york

Window blinds

Window treatment

XML Feeds

RSS 2.0: [Posts](#), [Comments](#)
Atom: [Posts](#), [Comments](#)

[What is RSS?](#)



Blinds New York

By The Shade Company

Blinds NY

Home

About The Shade Company

Contact

Log in



THE SHADE COMPANY

FREE CONSULTATION

☎ 212.222.8288

SEND AN EMAIL MESSAGE

To: admin

From: Your name.

Email: Your email address. (Will not be displayed on this site.)

Subject: Subject of email message.

Message:

Plain text only.

March 2011

Sun	Mon	Tue	Wed	Thu	Fri	Sat
		1	2	3	4	5
6	7	8	9	10	11	12
13	14	15	16	17	18	19
20	21	22	23	24	25	26
27	28	29	30	31		

<< < > >>

Blinds New York

This blog is not for people who can't see. This blog is people who see too much! These people need tinting or window covering. I will not try to shade here a smile, so go ahead and write funny comments about Blinds and Shades...

Recently

Archives

Categories

Latest comments

Search

All Words

Some Word
Entire phrase

Categories

All

Blinds new york

Motorized Shades

Shades new york

Window blinds

Window treatment

XML Feeds

RSS 2.0: [Posts](#), [Comments](#)
Atom: [Posts](#), [Comments](#)

[What is RSS?](#)



Blinds New York

By The Shade Company

Blinds NY

Home

About The Shade Company

Contact

Log in



THE SHADE COMPANY

FREE CONSULTATION

☎ 212.222.8288

SEND AN EMAIL MESSAGE

To: admin

From: Your name.

Email: Your email address. (Will not be displayed on this site.)

Subject: Subject of email message.

Message:

Plain text only.

March 2011

Sun	Mon	Tue	Wed	Thu	Fri	Sat
		1	2	3	4	5
6	7	8	9	10	11	12
13	14	15	16	17	18	19
20	21	22	23	24	25	26
27	28	29	30	31		

<< < > >>

Blinds New York

This blog is not for people who can't see. This blog is people who see too much! These people need tinting or window covering. I will not try to shade here a smile, so go ahead and write funny comments about Blinds and Shades...

Recently

Archives

Categories

Latest comments

Search

All Words

Some Word
Entire phrase

Categories

All

Blinds new york

Motorized Shades

Shades new york

Window blinds

Window treatment

XML Feeds

RSS 2.0: [Posts](#), [Comments](#)
Atom: [Posts](#), [Comments](#)

[What is RSS?](#)





Login form 

You will have to accept cookies in order to log in.

Login:

Password:

[Lost password ?](#)

[Abort login!](#)

b2evolution 2.4.2 – GPL License

©2001-2002 by Michel V & others – ©2003-2008 by François Planque & others.

Credits: [multiple blogs](#) | [webhosting](#)

Blinds New York

By The Shade Company

Blinds NY

Home

About The Shade Company

Contact

Log in



THE SHADE COMPANY

FREE CONSULTATION

☎ 212.222.8288

SEND AN EMAIL MESSAGE

To: admin

From: Your name.

Email: Your email address. (Will not be displayed on this site.)

Subject: Subject of email message.

Message:

Plain text only.

March 2011

Sun	Mon	Tue	Wed	Thu	Fri	Sat
		1	2	3	4	5
6	7	8	9	10	11	12
13	14	15	16	17	18	19
20	21	22	23	24	25	26
27	28	29	30	31		

<< < > >>

Blinds New York

This blog is not for people who can't see. This blog is people who see too much! These people need tinting or window covering. I will not try to shade here a smile, so go ahead and write funny comments about Blinds and Shades...

Recently

Archives

Categories

Latest comments

Search

All Words

Some Word
Entire phrase

Categories

All

Blinds new york

Motorized Shades

Shades new york

Window blinds

Window treatment

XML Feeds

RSS 2.0: [Posts](#), [Comments](#)
Atom: [Posts](#), [Comments](#)

[What is RSS?](#)



Blinds New York

By The Shade Company

Blinds NY

Home

About The Shade Company

Contact

Log in



THE SHADE COMPANY

FREE CONSULTATION

☎ 212.222.8288

SEND AN EMAIL MESSAGE

To: admin

From: Your name.

Email: Your email address. (Will not be displayed on this site.)

Subject: Subject of email message.

Message:

Plain text only.

March 2011

Sun	Mon	Tue	Wed	Thu	Fri	Sat
		1	2	3	4	5
6	7	8	9	10	11	12
13	14	15	16	17	18	19
20	21	22	23	24	25	26
27	28	29	30	31		

<< < > >>

Blinds New York

This blog is not for people who can't see. This blog is people who see too much! These people need tinting or window covering. I will not try to shade here a smile, so go ahead and write funny comments about Blinds and Shades...

Recently

Archives

Categories

Latest comments

Search

All Words

Some Word
Entire phrase

Categories

All

Blinds new york

Motorized Shades

Shades new york

Window blinds

Window treatment

XML Feeds

RSS 2.0: [Posts](#), [Comments](#)
Atom: [Posts](#), [Comments](#)

[What is RSS?](#)



Blinds New York

By The Shade Company

Blinds NY

Home

About The Shade Company

Contact

Log in



THE SHADE COMPANY

FREE CONSULTATION

☎ 212.222.8288

SEND AN EMAIL MESSAGE

To: admin

From: Your name.

Email: Your email address. (Will not be displayed on this site.)

Subject: Subject of email message.

Message:

Plain text only.

March 2011

Sun	Mon	Tue	Wed	Thu	Fri	Sat
		1	2	3	4	5
6	7	8	9	10	11	12
13	14	15	16	17	18	19
20	21	22	23	24	25	26
27	28	29	30	31		

<< < > >>

Blinds New York

This blog is not for people who can't see. This blog is people who see too much! These people need tinting or window covering. I will not try to shade here a smile, so go ahead and write funny comments about Blinds and Shades...

Recently

Archives

Categories

Latest comments

Search

All Words

Some Word
Entire phrase

Categories

All

Blinds new york

Motorized Shades

Shades new york

Window blinds

Window treatment

XML Feeds

RSS 2.0: [Posts](#), [Comments](#)
Atom: [Posts](#), [Comments](#)

[What is RSS?](#)





THE SHADE
COMPANY

FREE CONSULTATION

 212.222.8288

ARCHIVES FOR: DECEMBER 2008

Safety Tips For Solar Window Blinds For Your Children and Pets

by admin 

It is important for each of us to know how to raise awareness on the dangers of solar window blinds. Each year, many children are rushed to local emergency rooms due to injuries sustained when playing with the cords, or pulling on the cords that are part of window shades and window blinds. Pets have also been known to suffer from injuries due to these same types of cords.

As a parent, I feel that it is absolutely necessary to raise awareness of other parents and pet owners regarding this type of danger lurking in the home. Here, you will be taught how to know the dangers of window treatments.

The very first step that you can do to alert others on the dangers of window blinds is to observe these precautions in your own home. Make sure that all cords attached to solar window blinds are tied up highly. Not only will this help to avoid trips and potential falls, but it will divert the attention of children and animals from playing and pulling on the cords.

Window treatment in New York can install the best kind of window shades and window blinds together instruction on safety. Get the help of a window shades manufacturer in New York to give instruction on additional safety measures. By integrating safety in your own home, your visitors will see that you take the subject very seriously and may start to make the same changes and precautions in their homes, too.

The next thing that you can do to raise awareness about the dangers of cords on solar window blinds is to alert your local government. You should write letters to local legislators and those that work over your entire state. Persuade these individuals to make laws for daycare and educational facilities that require them to eliminate use of cords on window treatments.

In stating your case, it is important to offer alternatives for covering windows. This may include standard window treatments which can be purchased from a window blinds provider in New York.

To be honest, one of the last things that these officials have on their mind is safety with window blind cords. However, your letter will put this consideration out there.

If you have a knack for research, and can come up with some pretty strong evidence that solar window blinds pose potential dangers, you may elect to contact news

December 2008

Sun	Mon	Tue	Wed	Thu	Fri	Sat
	1	2	3	4	5	6
7	8	9	10	11	12	13
14	15	16	17	18	19	20
21	22	23	24	25	26	27
28	29	30	31			
<<	<	Current	>	>>		

Blinds New York

This blog is not for people who can't see. This blog is people who see too much! These people need tinting or window covering. I will not try to shade here a smile, so go ahead and write funny comments about Blinds and Shades...

Recently

Archives

Categories

Latest comments



Search

All Words

reporters. You can choose those that work for local papers, or those that work on television. These individuals have the ability to get the word out quickly.

They are always looking for a great news story, and something like blind cords that seems to be no danger at all, but prove to be a danger can make for some bold headlines! Now, you know how to raise awareness of the dangers of solar window blinds!

Categories: [Window blinds](#), [Blinds new york](#) Tags: [safety](#), [shades new york](#), [window blinds](#), [window blinds new york](#), [window shades](#), [window shades new york](#), [window treatment new york](#), [window treatment nyc](#), [window treatments](#)

 12/30/08 03:49:56 pm,  [Leave a comment »](#)



Some Word
Entire phrase

Categories

All

[Blinds new york](#)

[Motorized Shades](#)

[Shades new york](#)

[Window blinds](#)

[Window treatment](#)

XML Feeds

RSS 2.0: [Posts](#), [Comments](#)
Atom: [Posts](#), [Comments](#)

[What is RSS?](#)





THE SHADE COMPANY

FREE CONSULTATION

☎ 212.222.8288

ARCHIVES FOR: AUGUST 2008

Save on your heating bill

by admin

Windows

Windows can be one of your home's most attractive features. Windows provide views, daylighting, ventilation, and solar heating in the winter. Unfortunately, they can also account for 10% to 25% of your heating bill. During the summer, your air conditioner must work harder to cool hot air from sunny windows. Install **ENERGY STAR** windows and use curtains and shade to give your air conditioner and energy bill a break. If you live in the Sun Belt, look into new solar control spectrally selective windows, which can cut the cooling load by 10% to 15%.

If your home has single-pane windows, as almost half of U.S. homes do, consider replacing them. New doublepane windows with high-performance glass (e.g., low-e or spectrally selective) are available on the market. In colder climates, select windows that are gas filled with low emissivity (low-e) coatings on the glass to reduce heat loss. In warmer climates, select windows with spectrally selective coatings to reduce heat gain. If you are building a new home, you can offset some of the cost of installing more efficient windows because doing so allows you to buy smaller, less expensive heating and cooling equipment.

If you decide not to replace your windows, the simpler, less costly measures listed below can improve their performance.

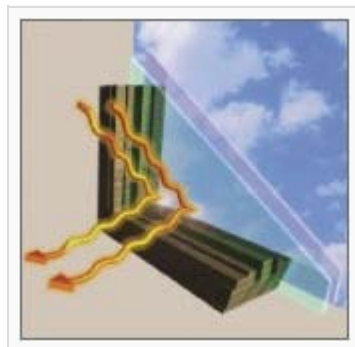

Cold Climate Windows Keep Heat In

Double-pane windows with low-e coating on the glass reflect heat back into the room

August 2008

Sun	Mon	Tue	Wed	Thu	Fri	Sat
					1	2
3	4	5	6	7	8	9
10	11	12	13	14	15	16
17	18	19	20	21	22	23
24	25	26	27	28	29	30
31						
<< <		Current		>		>>

Blinds New York

This blog is not for people who can't see. This blog is people who see too much! These people need tinting or window covering. I will not try to shade here a smile, so go ahead and write funny comments about Blinds and Shades...

Recently

Archives

Categories

Latest comments

Search

during the winter months.

Cold-Climate Window Tips

You can use a heavy-duty, clear plastic sheet on a frame or tape clear plastic film to the inside of your window frames during the cold winter months. Remember, the plastic must be sealed tightly to the frame to help reduce infiltration.

Install tight-fitting, insulating window shades on windows that feel drafty after weatherizing.

Close your curtains and shades at night; open them during the day.

Keep windows on the south side of your house clean to let in the winter sun.

Install exterior or interior storm windows; storm windows can reduce heat loss through the windows by 25% to 50%. Storm windows should have weatherstripping at all moveable joints; be made of strong, durable materials; and have interlocking or overlapping joints. Low-e storm windows save even more energy.

Repair and weatherize your current storm windows, if necessary.

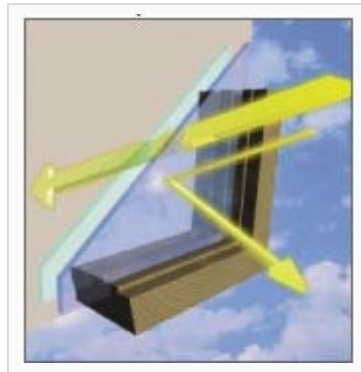

Warm Climate Windows Keep Heat Out

In the summertime, the sun shining through your windows heats up the room. Windows with spectrally selective coatings on the glass reflect some of the sunlight, keeping your rooms cooler.

Warm-Climate Window Tips

Install white window shades, drapes, or blinds to reflect heat away from the house.

Close curtains on south- and west-facing windows during the day.

Install awnings on south- and west-facing windows.

Apply sun-control or other reflective films on south-facing windows to reduce solar gain.

\$ Long-Term Savings Tip: Installing new, high-performance windows will improve your home's energy performance. While it may take many years for new windows to pay off in energy savings, the benefits of added comfort and improved aesthetics and functionality may make the investment worth it to you. Today, many new window technologies are available that are worth considering. Glazing materials (the glass part of the window) now come with a variety of selective coatings and other features; frames are available in aluminum, wood, vinyl, fiber glass, or combinations of these materials. Each type of glazing material and frame has advantages and disadvantages.

Shopping Tips for Windows

Look for the **ENERGY STAR**.

When you're shopping for new windows, look for the National Fenestration Rating Council label; it means the window's performance is certified.

Remember, the lower the U-value, the better the insulation. In colder climates, a U-value of 0.35 or below is recommended. These windows have at least double glazing and a low-e coating.

In warm climates, where summertime heat gain is the main concern, look for windows with double glazing and spectrally selective coatings that reduce heat gain.

Select windows with air leakage ratings of 0.3 cubic feet per minute or less.

In temperate climates with both heating and cooling seasons, select windows with both

All Words
Some Word
Entire phrase

Categories

All
Blinds new york
Motorized Shades
Shades new york
Window blinds
Window treatment

XML Feeds

RSS 2.0: Posts, Comments
Atom: Posts, Comments

[What is RSS?](#)





low U-values and low solar heat gain coefficient (SHGC) to maximize energy benefits.

Remember that new windows must be installed correctly to avoid air leaks around the frame. Look for a reputable, qualified installer.

Source: www1.eere.energy.gov

Categories: [Window blinds](#), [Window treatment](#)

 08/28/08 09:37:10 am,  [Leave a comment »](#)



Some YouTube Movies



by admin 

Let's start with funny idea to [Clean Window Blinds](#)

[How to Measure Roller Shades - outside mount](#)

[How to Make Your Own Curtains](#). Window Treatments in Easy Steps. Sewing the Tabs Together.

Categories: [Window treatment](#)

 08/25/08 05:11:58 pm,  [Leave a comment »](#)



Welcome to the Shades & Blinds Blog

by admin 

This blog is not for people who can't see. This blog is people who see too much! These people need tinting or window covering. I will not try to shade here a smile, so go ahead and write funny comments about Blinds and Shades...



The Shades & Blinds Blog covers these topics:

- **Motorized Shades:** Functionality is second to none with the choice of operating motorized blinds by remote control, switches, timers, AV and Home Automation Systems. Visit our site for Motorized Blinds, PowerRise Motorized Blinds and

PowerRise with Platinum Blinds.

- **Shades New York:** Create a warm and inviting setting with our Applause honeycomb shades, or a subtle hue with our Designer Screen shades, Duette honeycomb, Provenance woven wood, Trio Convertible and Vignette Modern Roman Shades.
- **Window Blinds:** At The Shade Company we have blinds to suit the entire family. Kid's Room Design, custom Design, Kids Roller Vcolor, safety rollerLine, Country Woods, L shape double open, Simple White Blinds and Vertical Solutions.
- **Window Treatment:** Window treatments add refinement and style to otherwise dull, boring windows. Shutters and awnings decorate the outside of your house, while blinds, shades, cornices, trim and draperies enhance the inside appeal. Use the guides in this section to learn how to replace, install and decorate your windows.
- More to come...

Categories: [Window blinds](#)

 08/14/08 11:51:33 am,  [3 comments »](#)



Blinds New York

By The Shade Company

Blinds NY

[Home](#)

[About The Shade Company](#)

[Contact](#)

[Log in](#)



THE SHADE COMPANY

FREE CONSULTATION

212.222.8288

SEND AN EMAIL MESSAGE

To: admin

From: Your name.

Email: Your email address. (Will not be displayed on this site.)

Subject: Subject of email message.

Message:

Plain text only.

March 2011

Sun	Mon	Tue	Wed	Thu	Fri	Sat
		1	2	3	4	5
6	7	8	9	10	11	12
13	14	15	16	17	18	19
20	21	22	23	24	25	26
27	28	29	30	31		

<< < > >>

Blinds New York

This blog is not for people who can't see. This blog is people who see too much! These people need tinting or window covering. I will not try to shade here a smile, so go ahead and write funny comments about Blinds and Shades...

Recently

Archives

Categories

Latest comments

Search

All Words

Some Word
Entire phrase

Categories

All

Blinds new york

Motorized Shades

Shades new york

Window blinds

Window treatment

XML Feeds

RSS 2.0: [Posts](#), [Comments](#)
Atom: [Posts](#), [Comments](#)

[What is RSS?](#)





Login form 

You will have to accept cookies in order to log in.

Login:

Password:

[Lost password ?](#)

[Abort login!](#)

b2evolution 2.4.2 – GPL License

©2001-2002 by Michel V & others – ©2003-2008 by François Planque & others.

Credits: [multiple blogs](#) | [webhosting](#)

Blinds New York

By The Shade Company

Blinds NY

Home

About The Shade Company

Contact

Log in



THE SHADE COMPANY

FREE CONSULTATION

212.222.8288

SEND AN EMAIL MESSAGE

To: admin

From: Your name.

Email: Your email address. (Will not be displayed on this site.)

Subject: Subject of email message.

Message:

Plain text only.

March 2011

Sun	Mon	Tue	Wed	Thu	Fri	Sat
		1	2	3	4	5
6	7	8	9	10	11	12
13	14	15	16	17	18	19
20	21	22	23	24	25	26
27	28	29	30	31		

<< < > >>

Blinds New York

This blog is not for people who can't see. This blog is people who see too much! These people need tinting or window covering. I will not try to shade here a smile, so go ahead and write funny comments about Blinds and Shades...

Recently

Archives

Categories

Latest comments

Search

All Words

Some Word
Entire phrase

Categories

All

Blinds new york

Motorized Shades

Shades new york

Window blinds

Window treatment

XML Feeds

RSS 2.0: [Posts](#), [Comments](#)
Atom: [Posts](#), [Comments](#)

[What is RSS?](#)





Login form 

You will have to accept cookies in order to log in.

Login:

Password:

[Lost password ?](#)

[Abort login!](#)

b2evolution 2.4.2 – GPL License

©2001-2002 by Michel V & others – ©2003-2008 by François Planque & others.

Credits: [multiple blogs](#) | [webhosting](#)

Blinds New York

By The Shade Company

Blinds NY

Home

About The Shade Company

Contact

Log in



THE SHADE COMPANY

FREE CONSULTATION

212.222.8288

SEND AN EMAIL MESSAGE

To: admin

From: Your name.

Email: Your email address. (Will not be displayed on this site.)

Subject: Subject of email message.

Message:

Plain text only.

March 2011

Sun	Mon	Tue	Wed	Thu	Fri	Sat
		1	2	3	4	5
6	7	8	9	10	11	12
13	14	15	16	17	18	19
20	21	22	23	24	25	26
27	28	29	30	31		

<< < > >>

Blinds New York

This blog is not for people who can't see. This blog is people who see too much! These people need tinting or window covering. I will not try to shade here a smile, so go ahead and write funny comments about Blinds and Shades...

Recently

Archives

Categories

Latest comments

Search

All Words

Some Word
Entire phrase

Categories

All

Blinds new york

Motorized Shades

Shades new york

Window blinds

Window treatment

XML Feeds

RSS 2.0: [Posts](#), [Comments](#)
Atom: [Posts](#), [Comments](#)

[What is RSS?](#)





Login form 

You will have to accept cookies in order to log in.

Login:

Password:

[Lost password ?](#)

[Abort login!](#)

b2evolution 2.4.2 – GPL License

©2001-2002 by Michel V & others – ©2003-2008 by François Planque & others.

Credits: [multiple blogs](#) | [webhosting](#)

Blinds New York

By The Shade Company

Blinds NY

Home

About The Shade Company

Contact

Log in



THE SHADE COMPANY

FREE CONSULTATION

212.222.8288

SEND AN EMAIL MESSAGE

To: admin

From: Your name.

Email: Your email address. (Will not be displayed on this site.)

Subject: Subject of email message.

Message:

Plain text only.

March 2011

Sun	Mon	Tue	Wed	Thu	Fri	Sat
		1	2	3	4	5
6	7	8	9	10	11	12
13	14	15	16	17	18	19
20	21	22	23	24	25	26
27	28	29	30	31		

<< < > >>

Blinds New York

This blog is not for people who can't see. This blog is people who see too much! These people need tinting or window covering. I will not try to shade here a smile, so go ahead and write funny comments about Blinds and Shades...

Recently

Archives

Categories

Latest comments

Search

All Words

Some Word
Entire phrase

Categories

All

Blinds new york

Motorized Shades

Shades new york

Window blinds

Window treatment

XML Feeds

RSS 2.0: [Posts](#), [Comments](#)
Atom: [Posts](#), [Comments](#)

[What is RSS?](#)





Login form 

You will have to accept cookies in order to log in.

Login:

Password:

[Lost password ?](#)

[Abort login!](#)

b2evolution 2.4.2 – GPL License

©2001-2002 by Michel V & others – ©2003-2008 by François Planque & others.

Credits: [multiple blogs](#) | [webhosting](#)

Blinds New York

By The Shade Company

Blinds NY

[Home](#)

[About The Shade Company](#)

[Contact](#)

[Log in](#)



THE SHADE COMPANY

FREE CONSULTATION

☎ 212.222.8288

ARCHIVES FOR: MARCH 2009

Sorry, there is nothing to display...

March 2009

Sun	Mon	Tue	Wed	Thu	Fri	Sat
1	2	3	4	5	6	7
8	9	10	11	12	13	14
15	16	17	18	19	20	21
22	23	24	25	26	27	28
29	30	31				
<< <		Current		>		>>

Blinds New York

This blog is not for people who can't see. This blog is people who see too much! These people need tinting or window covering. I will not try to shade here a smile, so go ahead and write funny comments about Blinds and Shades...

Recently

Archives

Categories

Latest comments

Search

All Words

Some Word
Entire phrase

Categories

All

Blinds new york

Motorized Shades

Shades new york

Window blinds

Window treatment

XML Feeds

RSS 2.0: [Posts](#), [Comments](#)

Atom: [Posts](#), [Comments](#)

[What is RSS?](#)



Blinds New York

By The Shade Company

Blinds NY

[Home](#)

[About The Shade Company](#)

[Contact](#)

[Log in](#)



THE SHADE
COMPANY

FREE CONSULTATION

☎ 212.222.8288

ARCHIVES FOR: FEBRUARY 2010

Sorry, there is nothing to display...

February 2010

Sun	Mon	Tue	Wed	Thu	Fri	Sat
	1	2	3	4	5	6
7	8	9	10	11	12	13
14	15	16	17	18	19	20
21	22	23	24	25	26	27
28						
<<	<	Current	>	>>		

Blinds New York

This blog is not for people who can't see. This blog is people who see too much! These people need tinting or window covering. I will not try to shade here a smile, so go ahead and write funny comments about Blinds and Shades...

Recently

Archives

Categories

Latest comments

Search

All Words

Some Word
Entire phrase

Categories

All

Blinds new york

Motorized Shades

Shades new york

Window blinds

Window treatment

XML Feeds

RSS 2.0: [Posts](#), [Comments](#)
Atom: [Posts](#), [Comments](#)

[What is RSS?](#)



Blinds New York

By The Shade Company

Blinds NY

[Home](#)

[About The Shade Company](#)

[Contact](#)

[Log in](#)



THE SHADE COMPANY

FREE CONSULTATION

☎ 212.222.8288

ARCHIVES FOR: APRIL 2010

Sorry, there is nothing to display...

April 2010

Sun	Mon	Tue	Wed	Thu	Fri	Sat
				1	2	3
4	5	6	7	8	9	10
11	12	13	14	15	16	17
18	19	20	21	22	23	24
25	26	27	28	29	30	
<<	<	Current	>	>>		

Blinds New York

This blog is not for people who can't see. This blog is people who see too much! These people need tinting or window covering. I will not try to shade here a smile, so go ahead and write funny comments about Blinds and Shades...

Recently

Archives

Categories

Latest comments

Search

All Words

Some Word
Entire phrase

Categories

All

Blinds new york

Motorized Shades

Shades new york

Window blinds

Window treatment

XML Feeds

RSS 2.0: [Posts](#), [Comments](#)

Atom: [Posts](#), [Comments](#)

[What is RSS?](#)



Blinds New York

By The Shade Company

Blinds NY

Home

About The Shade Company

Contact

Log in



THE SHADE COMPANY

FREE CONSULTATION

212.222.8288

SEND AN EMAIL MESSAGE

To: admin

From: Your name.

Email: Your email address. (Will not be displayed on this site.)

Subject: Subject of email message.

Message:

Plain text only.

March 2011

Sun	Mon	Tue	Wed	Thu	Fri	Sat
		1	2	3	4	5
6	7	8	9	10	11	12
13	14	15	16	17	18	19
20	21	22	23	24	25	26
27	28	29	30	31		

<< < > >>

Blinds New York

This blog is not for people who can't see. This blog is people who see too much! These people need tinting or window covering. I will not try to shade here a smile, so go ahead and write funny comments about Blinds and Shades...

Recently

Archives

Categories

Latest comments

Search

All Words

Some Word
Entire phrase

Categories

All

Blinds new york

Motorized Shades

Shades new york

Window blinds

Window treatment

XML Feeds

RSS 2.0: [Posts](#), [Comments](#)
Atom: [Posts](#), [Comments](#)

[What is RSS?](#)





Login form 

You will have to accept cookies in order to log in.

Login:

Password:

[Lost password ?](#)

[Abort login!](#)

b2evolution 2.4.2 – GPL License

©2001-2002 by Michel V & others – ©2003-2008 by François Planque & others.

Credits: [multiple blogs](#) | [webhosting](#)

Blinds New York

By The Shade Company

Blinds NY

[Home](#)

[About The Shade Company](#)

[Contact](#)

[Log in](#)



THE SHADE COMPANY

FREE CONSULTATION

☎ 212.222.8288

ARCHIVES FOR: JANUARY 2011

Sorry, there is nothing to display...

January 2011

Sun	Mon	Tue	Wed	Thu	Fri	Sat
						1
2	3	4	5	6	7	8
9	10	11	12	13	14	15
16	17	18	19	20	21	22
23	24	25	26	27	28	29
30	31					
<< <		Current		>		>>

Blinds New York

This blog is not for people who can't see. This blog is people who see too much! These people need tinting or window covering. I will not try to shade here a smile, so go ahead and write funny comments about Blinds and Shades...

Recently

Archives

Categories

Latest comments

Search

All Words
Some Word
Entire phrase

Categories

All

Blinds new york

Motorized Shades

Shades new york

Window blinds

Window treatment

XML Feeds

RSS 2.0: [Posts](#), [Comments](#)
Atom: [Posts](#), [Comments](#)

[What is RSS?](#)



Blinds New York

By The Shade Company

Blinds NY

[Home](#)

[About The Shade Company](#)

[Contact](#)

[Log in](#)



THE SHADE
COMPANY

FREE CONSULTATION

 212.222.8288

ARCHIVES FOR: FEBRUARY 2012

Sorry, there is nothing to display...

February 2012

Sun	Mon	Tue	Wed	Thu	Fri	Sat
			1	2	3	4
5	6	7	8	9	10	11
12	13	14	15	16	17	18
19	20	21	22	23	24	25
26	27	28	29			
<<	<	Current				>

Blinds New York

This blog is not for people who can't see. This blog is people who see too much! These people need tinting or window covering. I will not try to shade here a smile, so go ahead and write funny comments about Blinds and Shades...

Recently

Archives

Categories

Latest comments

Search

All Words

Some Word
Entire phrase

Categories

All

Blinds new york

Motorized Shades

Shades new york

Window blinds

Window treatment

XML Feeds

RSS 2.0: [Posts](#), [Comments](#)
Atom: [Posts](#), [Comments](#)

[What is RSS?](#)



Blinds New York

By The Shade Company

Blinds NY

Home

About The Shade Company

Contact

Log in



THE SHADE COMPANY

FREE CONSULTATION

212.222.8288

SEND AN EMAIL MESSAGE

To: admin

From: Your name.

Email: Your email address. (Will not be displayed on this site.)

Subject: Subject of email message.

Message:

Plain text only.

March 2011

Sun	Mon	Tue	Wed	Thu	Fri	Sat
		1	2	3	4	5
6	7	8	9	10	11	12
13	14	15	16	17	18	19
20	21	22	23	24	25	26
27	28	29	30	31		

<< < > >>

Blinds New York

This blog is not for people who can't see. This blog is people who see too much! These people need tinting or window covering. I will not try to shade here a smile, so go ahead and write funny comments about Blinds and Shades...

Recently

Archives

Categories

Latest comments

Search

All Words

Some Word
Entire phrase

Categories

All

Blinds new york

Motorized Shades

Shades new york

Window blinds

Window treatment

XML Feeds

RSS 2.0: [Posts](#), [Comments](#)
Atom: [Posts](#), [Comments](#)

[What is RSS?](#)





Login form 

You will have to accept cookies in order to log in.

Login:

Password:

[Lost password ?](#)

[Abort login!](#)

b2evolution 2.4.2 – GPL License

©2001-2002 by Michel V & others – ©2003-2008 by François Planque & others.

Credits: [multiple blogs](#) | [webhosting](#)

Blinds New York

By The Shade Company

Blinds NY

Home

About The Shade Company

Contact

Log in



THE SHADE COMPANY

FREE CONSULTATION

☎ 212.222.8288

ARCHIVES FOR: MAY 2011

Sorry, there is nothing to display...

May 2011

Sun	Mon	Tue	Wed	Thu	Fri	Sat
1	2	3	4	5	6	7
8	9	10	11	12	13	14
15	16	17	18	19	20	21
22	23	24	25	26	27	28
29	30	31				
<<	<	Current				>

Blinds New York

This blog is not for people who can't see. This blog is people who see too much! These people need tinting or window covering. I will not try to shade here a smile, so go ahead and write funny comments about Blinds and Shades...

Recently

Archives

Categories

Latest comments

Search

All Words

Some Word
Entire phrase

Categories

All

Blinds new york

Motorized Shades

Shades new york

Window blinds

Window treatment

XML Feeds

RSS 2.0: [Posts](#), [Comments](#)
Atom: [Posts](#), [Comments](#)

[What is RSS?](#)



Blinds New York

By The Shade Company

Blinds NY

Home

About The Shade Company

Contact

Log in



THE SHADE COMPANY

FREE CONSULTATION

212.222.8288

SEND AN EMAIL MESSAGE

To: admin

From: Your name.

Email: Your email address. (Will not be displayed on this site.)

Subject: Subject of email message.

Message:

Plain text only.

March 2011

Sun	Mon	Tue	Wed	Thu	Fri	Sat
		1	2	3	4	5
6	7	8	9	10	11	12
13	14	15	16	17	18	19
20	21	22	23	24	25	26
27	28	29	30	31		

<< < > >>

Blinds New York

This blog is not for people who can't see. This blog is people who see too much! These people need tinting or window covering. I will not try to shade here a smile, so go ahead and write funny comments about Blinds and Shades...

Recently

Archives

Categories

Latest comments

Search

All Words

Some Word
Entire phrase

Categories

All

Blinds new york

Motorized Shades

Shades new york

Window blinds

Window treatment

XML Feeds

RSS 2.0: [Posts](#), [Comments](#)
Atom: [Posts](#), [Comments](#)

[What is RSS?](#)

